



Operator's Manual

MT720

Offset Finish Mower





500 Venture Drive
Orrville, OH 44667
www.ventrac.com

To the Owner Contact Information and Product Identification

If you need to contact an authorized Ventrac dealer for information on servicing your product, always provide the product model and serial numbers.

Please fill in the following information for future reference. See the picture(s) below to find the location of the identification numbers. Record them in the spaces provided.

Dealer _____ Date of Purchase: _____

Dealer Address: _____

Dealer Phone Number: _____ Dealer Fax Number: _____

With your mobile device, you can scan the QR code on the serial number plate to access manuals, warranty, and other product information.

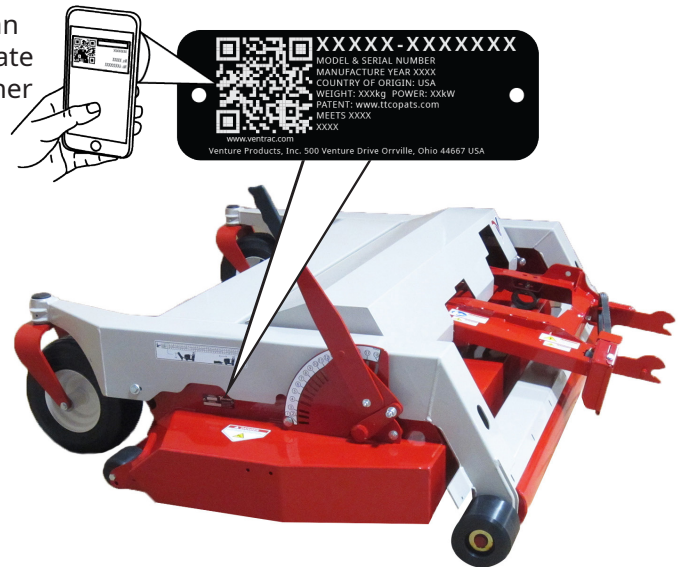

Model # _____

Serial # _____

Venture Products Inc. reserves the right to make changes in design or specifications without obligation to make like changes on previously manufactured products.

TABLE OF CONTENTS

INTRODUCTION	PAGE 5
Product Description	5
Why Do I Need an Operator’s Manual?	5
Using Your Manual	6
Manual Glossary	6
SAFETY	PAGE 7
General Safety Procedures	7
Training Required	7
Requirements for Personal Protective Equipment (PPE)	7
Operation Safety.	7
Keep Riders Off	9
Operating On Slopes	9
Truck Or Trailer Transport	10
Maintenance	10
Fuel Safety	11
Hydraulic Safety	12
Cutting Unit Safety	13
Optional Hydraulic Flip Up Kit Safety	13
Safety Decals.	14
OPERATIONAL CONTROLS	PAGE 16
Operational Control Locations	16
Height Adjustment Handle (A)	16
Belt Tension Handle (B)	16
Primary SDLA Control Lever	16
Secondary SDLA Control Lever.	16
Weight Transfer	16
GENERAL OPERATION	PAGE 17
Daily Inspection	17
Attaching	17
Detaching.	17
Operating Procedure	17
Transport of the Attachment.	18
Cutting Height Adjustment.	18
Front Roller Position.	18
Mulching Kit (Optional Accessory).	18

TABLE OF CONTENTS

SERVICE	PAGE 19
Cleaning and General Maintenance	19
Main Deck Cover Shield Removal and Installation.	19
Deck Flip Up Procedure (Service Position)	19
Mower Blade Inspection/Replacement	21
Mower Blade Sharpening.	21
Belt Inspection	21
Attachment Belt Replacement	21
Deck Belt Replacement	21
Deck Belt Tension Adjustment	22
Deck Leveling Procedure	22
Tire Pressure	23
Lubrication Locations	23
Storage	24
Maintenance Schedule	25
Maintenance Checklist	26
SPECIFICATIONS	PAGE 27
Dimensions.	27
Features.	27

INTRODUCTION



Venture Products Inc. is pleased to provide you with your new Ventrac MT720 mower! We hope that Ventrac equipment will provide you with a ONE Tractor Solution.

Please visit our website, or contact your authorized Ventrac dealer for a complete list of items available for your new MT720 mower.

	Item Description	Part Number
Accessories	MS/MT720 mulching kit (includes 79.0106 mulch blades)	70.8164
	Low Lift Blade (requires 3)	79.0104
	Gator Blade (requires 3)	79.0107
	Mulch Blade (requires 3)	70.0106
	Hydraulic Deck Flip Up Kit	70.8214
	Flat Free Tire/Wheel Assembly (requires 2)	53.0214

Product Description

The MT720 mower is designed for the sole purpose of finish mowing and is built to be the best cutting and longest lasting finish mower available. The high strength steel mower deck has an obstruction free grass chamber to minimize buildup and provide easy cleaning. A rugged all steel reinforced carrier frame incorporates a full length rear roller for even cutting and grass striping.

The MT720 mower deck is offset 16.5 cm (6-1/2 inches) to the left side to aid in mowing along ditches, ponds, and trimming around obstacles.

The MT720 features a 183 cm (72 inch) cutting width. Ventrac's Linear Adjustment System provides eighteen cutting height positions from 2.54 cm (1 inch) to 12.7 cm (5 inch). A single hand adjustment lever allows for a quick change in cutting height selection. A slide release allows the handle to be returned to deck level, preventing it from catching on low branches and shrubs.

The deck can be tilted up to a near vertical position for cleaning, maintenance, or storage. An optional hydraulic deck flip up kit uses the power unit hydraulic system to flip the deck up to the vertical position.

Why Do I Need an Operator's Manual?

This manual has been created to help you gain the important knowledge of what is needed to safely operate and maintain your machine, and to avoid injury and product damage. It is divided into chapters for convenient reference of the appropriate information.

You must read and understand the operator's manual for each piece of Ventrac equipment you own. Reading the operator's manual will help you become familiar with each specific piece of equipment. If this manual becomes damaged or unreadable, it should be replaced immediately. Contact your local Ventrac dealer for a replacement.

When using a Ventrac attachment, be sure to read and follow the safety and operating instructions of both the power unit and the attachment being used to ensure the safest operation possible.

The information in this manual provides the operator with the safest procedures to operate the machine while getting the maximum use out of the unit. Failure to follow the safety precautions listed in this manual may result in personal injury and/or damage to the equipment.

INTRODUCTION

Using Your Manual

This manual identifies potential hazards and safety concerns to help you, as well as others, avoid personal injury and/or damage to the equipment.

Safety should always be the first priority when working on or operating equipment. Accidents are more likely to occur when proper operating procedures are not followed or inexperienced operators are involved.

SYMBOL DEFINITIONS



This symbol identifies potential health and safety hazards. It marks safety precautions. Your safety and the safety of others is involved.

There are three signal words that describe the level of safety concern: Danger, Warning, and Caution.

SIGNAL WORD DEFINITIONS

DANGER

Indicates an imminently hazardous situation which, if not avoided, will result in death or serious injury. This signal word is limited to the most extreme cases.

WARNING

Indicates a potentially hazardous situation which, if not avoided, could result in death or serious injury.

CAUTION

Indicates a potentially hazardous situation which, if not avoided, may result in minor or moderate injury and/or property damage. It may also be used to alert against unsafe practices.

This manual also uses two words to highlight information. **ATTENTION** calls attention to special mechanical information to prevent equipment damage and/or best practices for equipment service and care.

NOTE emphasizes general information that is worthy of special attention.

Note: Right-Hand and Left-Hand orientations may be referred to at different places throughout this manual. Right-Hand and Left-Hand is determined as if facing forward from the operator station.

Manual Glossary

- Power Unit** A Ventrac tractor or other Ventrac engine powered device that may be operated by itself or with an attachment or accessory.
- Attachment** A piece of Ventrac equipment that requires a Power Unit for operation.
- Accessory** A device that attaches to a Power Unit or Attachment to extend its capabilities.
- Machine** Describes any "Attachment" or "Accessory" that is used in conjunction with a power unit.

SAFETY



General Safety Procedures for Ventrac Power Units, Attachments, & Accessories



Training Required

- The owner of this machine is solely responsible for properly training the operators.
- The owner/operator is solely responsible for the operation of this machine and for the prevention of accidents or injuries occurring to him/herself, other people, or property.
- Do not allow operation or service by children or untrained personnel. Local regulations may restrict the age of the operator.
- Before operating this machine, read the operator's manual and understand its contents.
- If the operator of the machine cannot understand this manual, then it is the responsibility of this machine's owner to fully explain the material within this manual to the operator.
- Learn and understand the use of all the controls.
- Know how to stop the power unit and the attachments quickly in the event of an emergency.

Requirements for Personal Protective Equipment (PPE)

- The owner is responsible for ensuring that all the operators use the proper PPE while operating the machine. Whenever you use the machine, use the following PPE:
- Certified eye protection and hearing protection.
- Closed toe, slip resistant footwear.
- Long pants or trousers.
- A dust mask for dusty conditions.
- Additional PPE may be required. Refer to the product safety procedures for any additional requirements.

Operation Safety

- Secure long hair and loose clothing. Do not wear jewelry.
- Inspect the machine before operation. Repair or replace any damaged, worn, or missing parts. Be sure the guards and shields are in proper working condition and are secured in place. Make any necessary adjustments before operating the machine.
- Some pictures in this manual may show shields or covers opened or removed in order to clearly illustrate the instructions. Under no circumstance should the machine be operated without these devices in place.
- Alterations or modifications to this machine can reduce safety and could cause damage to the machine. Do not alter the safety devices or operate with the shields or covers removed.
- Before each use, verify that all the controls function properly and inspect all the safety devices. Do not operate if the controls or safety devices are not in proper working condition.
- Check the parking brake function before operating. Repair or adjust the parking brake if necessary.
- Observe and follow all of the safety decals.
- All the controls are to be operated from the operator's station only.
- Always wear a seat belt if the machine has a roll cage/bar installed and in the upright position.

SAFETY



General Safety Procedures for Ventrac Power Units, Attachments, & Accessories



- Ensure the attachment or accessory is locked or fastened securely to the power unit before operating.
- Ensure that all bystanders are clear of the power unit and the attachment before operating. Stop the machine if someone enters your work area.
- Always be alert to what is happening around you, but do not lose focus on the task you are performing. Always look in the direction the machine is moving.
- Look behind and down before backing up to be sure of a clear path.
- If you hit an object, stop and inspect the machine. Make any necessary repairs before operating the machine again.
- Stop operation immediately at any sign of equipment failure. An unusual noise can be a warning of equipment failure or a sign that maintenance is required. Make any necessary repairs before operating the machine again.
- If equipped with a high/low range feature, never shift between high and low range while on a slope. Always move the machine to level ground and engage the parking brake before shifting range.
- Do not leave the machine unattended while it is running.
- Always park the machine on level ground.
- Always shut off the engine when connecting the attachment drive belt to the power unit.
- Never leave the operator's station without lowering the attachment to the ground, engaging the parking brake, shutting off the engine, and removing the ignition key. Make sure all moving parts have come to a complete stop before dismounting.
- Never leave the machine unattended without lowering the attachment to the ground, engaging the parking brake, shutting off the engine, and removing the ignition key.
- Only operate in well-lit conditions.
- Do not operate when there is a risk of lightning.
- Never direct the discharge of any attachment in the direction of people, buildings, animals, vehicles, or other objects of value.
- Never discharge material against a wall or obstruction. The material may ricochet back toward the operator.
- Use extra caution when approaching blind corners, shrubs, trees, or other objects that may obscure your vision.
- Do not run the engine in a building without adequate ventilation.
- Do not touch the engine or the muffler while the engine is running or immediately after stopping the engine. These areas may be hot enough to cause a burn.
- Do not change the engine governor settings or over-speed the engine. Operating the engine at excessive speeds may increase the hazard of personal injury.
- To reduce the hazard of fire, keep the battery compartment, engine, and muffler areas free of grass, leaves, excessive grease, and other flammable materials.
- Clear the working area of objects that might be hit or thrown from the machine.

SAFETY



General Safety Procedures for Ventrac Power Units, Attachments, & Accessories



- Keep people and pets out of the working area.
- Know the work area well before operation. Do not operate where traction or stability is questionable.
- Reduce speed when you are operating over rough ground.
- Equipment can cause serious injury and/or death when improperly used. Before operating, know and understand the operation and safety of the power unit and the attachment being used.
- Do not operate the machine if you are not in good physical and mental health, if you will be distracted by personal devices, or if you are under the influence of any substance which might impair your decisions, dexterity, or judgment.
- Children are attracted to machine activity. Be aware of children and do not allow them in the work area. Turn off the machine if a child enters the work area.
- Power units, attachments, and accessories are not designed or intended for travel on public roadways. Never operate or travel on public roads or highways.
- Operate with safety lights when operating near roadways.
- Slow down and be careful of traffic when operating near or crossing roadways. Stop before crossing roads or sidewalks. Use care when approaching areas or objects that may obscure vision.

Keep Riders Off

- Only allow the operator on the power unit. Keep riders off.
- Never allow riders on any attachment or accessory.

Operating On Slopes

- Slopes can cause loss-of-control and tip-over accidents, which can result in severe injury or death. Be familiar with the emergency parking brake, along with the power unit controls and their functions.
- If the power unit is equipped with a fold down roll bar, it must be locked in the upright position when operating on any slope.
- Use low range (if equipped) when operating on slopes greater than 15 degrees.
- Do not stop or start suddenly when operating on slopes.
- Never shift between high and low range while on a slope. Always move the power unit to level ground and engage the parking brake before shifting range or placing the power unit in neutral.
- Variables such as wet surfaces and loose ground will reduce the degree of safety. Do not drive where the machine could lose traction or tip over.
- Keep alert for hidden hazards in the terrain.
- Stay away from drop-offs, ditches, and embankments.
- Sharp turns should be avoided when operating on slopes.
- Pulling loads on hills decreases safety. It is the responsibility of the owner/operator to determine loads that can safely be controlled on slopes.

SAFETY



General Safety Procedures for Ventrac Power Units, Attachments, & Accessories



- Transport the machine with the attachment lowered or close to the ground to improve stability.
- While operating on slopes, drive in an up and down direction whenever possible. If turning is necessary while driving across slopes, reduce your speed and turn slowly in the downhill direction.
- Ensure a sufficient supply of fuel for continuous operation. A minimum of one-half tank of fuel is recommended.

Truck Or Trailer Transport

- Use care when loading or unloading the machine into a truck or trailer.
- Use full width ramps for loading the machine into a truck or trailer.
- The parking brake is not sufficient to lock the machine during transport. Always secure the power unit and/or attachment to the transporting vehicle securely using straps, chains, cables, or ropes. Both the front and rear straps should be directed down and outward from the machine.
- Shut off the fuel supply to the power unit during transport on a truck or trailer.
- If equipped, turn the battery disconnect switch to the Off position to shut off electrical power.

Maintenance

- Keep the safety decals legible. Remove all grease, dirt, and debris from the safety decals and instructional labels.
- If any decals are faded, illegible, or missing, contact your dealer promptly for replacements.
- When new components are installed, be sure that the current safety decals are affixed to the replacement components.
- If any component requires replacement, use only original Ventrac replacement parts.
- Always turn the battery disconnect to the Off position or disconnect the battery before performing any repairs. Disconnect the negative terminal first and the positive terminal last. Reconnect the positive terminal first and the negative terminal last.
- Keep all bolts, nuts, screws, and other fasteners properly tightened.
- Always lower the attachment to the ground, engage the parking brake, shut off the engine, and remove the ignition key. Make sure all moving parts have come to a complete stop before cleaning, inspecting, adjusting, or repairing.
- If the power unit, attachment, or accessory requires repairs or adjustments not instructed in the operator's manual, the power unit, attachment, or accessory must be taken to an authorized Ventrac dealer for service.
- Never perform maintenance on the power unit and/or attachment if someone is in the operator's station.
- Always use protective glasses when handling the battery.
- Check the fuel lines for tightness and wear on a regular basis. Tighten or repair them as needed.
- To reduce the hazard of fire, keep the battery compartment, engine, and muffler areas free of grass, leaves, and excess grease.
- Do not touch the engine, the muffler, or other exhaust components while the engine is running or immediately after stopping the engine. These areas may be hot enough to cause a burn.

SAFETY



General Safety Procedures for Ventrac Power Units, Attachments, & Accessories



- Allow the engine to cool before storing and do not store near an open flame.
- Do not change the engine governor settings or over-speed the engine. Operating engine at excessive speeds may increase the hazard of personal injury.
- Springs may contain stored energy. Use caution when disengaging or removing springs and/or spring loaded components.
- An obstruction or blockage in a drive system or moving/rotating parts may cause a buildup of stored energy. When the obstruction or blockage is removed, the drive system or moving/rotating parts may move suddenly. Do not attempt to remove an obstruction or blockage with your hands. Keep your hands, feet, and clothing away from all power-driven parts.

Fuel Safety

- To avoid personal injury or property damage, use extreme care in handling gasoline. Gasoline is extremely flammable and the vapors are explosive.
- Do not refuel the machine while smoking or at a location near flames or sparks.
- Always refuel the machine outdoors.
- Do not store the machine or fuel container indoors where the fumes or fuel can reach an open flame, spark, or pilot light.
- Only store fuel in an approved container. Keep out of the reach of children.
- Never fill containers inside a vehicle or on a truck or trailer bed with a plastic liner. Always place the containers on the ground away from your vehicle before filling.
- Remove the machine from the truck or trailer and refuel it on the ground. If this is not possible, refuel the machine using a portable container, rather than from a fuel dispenser nozzle.
- Never remove the fuel cap or add fuel with the engine running. Allow the engine to cool before refueling.
- Never remove the fuel cap while on a slope. Only remove the fuel cap when parked on a level surface.
- Replace the fuel tank cap and the container cap securely.
- Do not overfill the fuel tank. Only fill to the bottom of the fuel neck, do not fill the fuel neck full. Overfilling of the fuel tank could result in engine flooding, fuel leakage from the tank, and/or damage to the emissions control system.
- If fuel is spilled, do not attempt to start the engine. Move the power unit away from the fuel spill and avoid creating any source of ignition until the fuel vapors have dissipated.
- If the fuel tank must be drained, it should be drained outdoors into an approved container.
- Check the fuel lines for tightness and wear on a regular basis. Tighten or repair them as needed.
- The fuel system is equipped with a shut-off valve. Shut off the fuel when transporting the machine to and from the job, when parking the machine indoors, or when servicing the fuel system.

SAFETY



General Safety Procedures for Ventrac Power Units, Attachments, & Accessories



Hydraulic Safety

- Make sure the hydraulic connections are tight and all hydraulic hoses and tubes are in good condition. Repair any leaks and replace any damaged or deteriorated hoses or tubes before starting the machine.
- Hydraulic leaks can occur under high pressure. Hydraulic leaks require special care and attention.
- Use a piece of cardboard and a magnifying glass to locate suspected hydraulic leaks.
- Keep your body and hands away from pinhole leaks or nozzles that eject high pressure hydraulic fluid. Hydraulic fluid escaping under high pressure can penetrate the skin causing serious injury, leading to severe complications and/or secondary infections if left untreated. If hydraulic fluid is injected into the skin, seek immediate medical attention no matter how minor the injury appears.
- The hydraulic system may contain stored energy. Before performing maintenance or repairs on the hydraulic system, remove any attachments, engage the parking brake, disengage the weight transfer system (if equipped), shut off the engine, and remove the ignition key. To relieve pressure on the auxiliary hydraulic system, shut off the power unit engine and move the hydraulic control lever left and right before disconnecting the auxiliary hydraulic quick couplers.

SAFETY



MT720 Safety Procedures



Cutting Unit Safety

- Rotating Blade Hazard: Contact with the rotating mower blades or other moving parts may cause personal injury. Keep your hands and feet away.
- Rotation of one blade may cause another blade to rotate.
- Thrown Object Hazard: Do not direct the mower discharge toward people, animals, or buildings. Never operate with the deflector(s) removed.
- Always shut off the PTO to stop the mower blades whenever you are not mowing, especially when crossing loose terrain such as gravel.
- Never raise the mower deck with the blades running.

Optional Hydraulic Flip Up Kit Safety

- The attachment hydraulic system may contain stored energy. Before performing maintenance or repairs on the hydraulic system, the attachment's auxiliary hydraulic hoses must be disconnected from the power unit. Lower the attachment to the ground, shut off power unit engine, move the secondary SDLA lever left and right to relieve auxiliary hydraulic pressure, and disconnect the auxiliary hydraulic quick couplers.
- Do not disconnect the auxiliary hydraulic hoses for the optional hydraulic flip up kit while the deck is tilted up in the service position.

SAFETY

Safety Decals

The following safety decals must be maintained on your attachment.

Keep all safety decals legible. Remove all grease, dirt, and debris from safety decals and instructional labels. If any decals are faded, illegible, or missing, contact your dealer promptly for replacements.

When new components are installed, be sure that current safety decals are affixed to the replacement components.

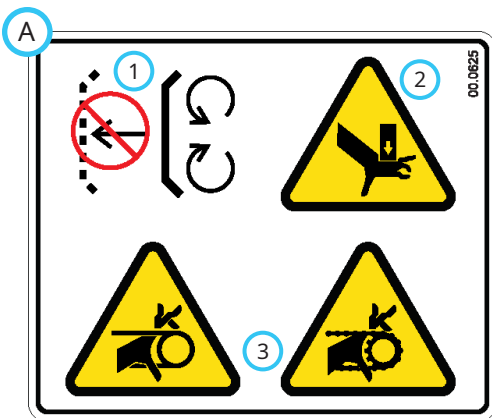
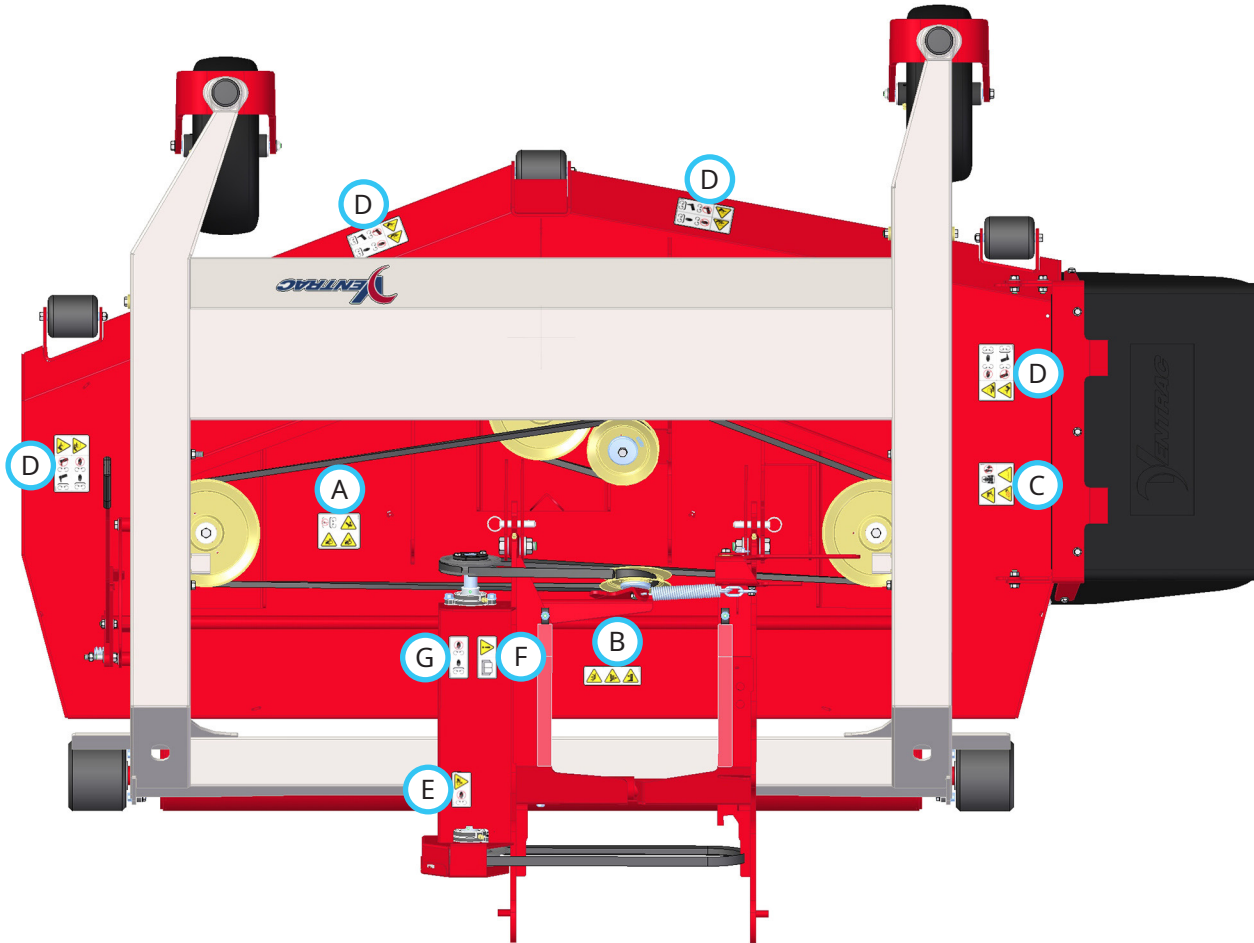

1. Shield missing - do not operate.
2. Pinching/crushing hazard.
3. Fingers or hand entanglement hazard.

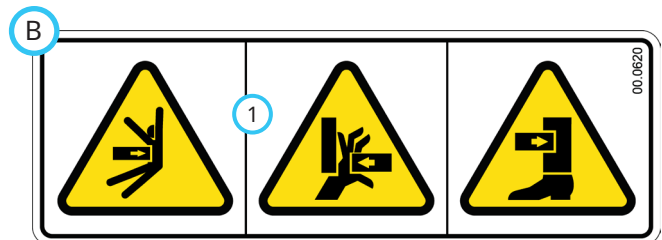

1. Pinching or crushing hazard.

SAFETY

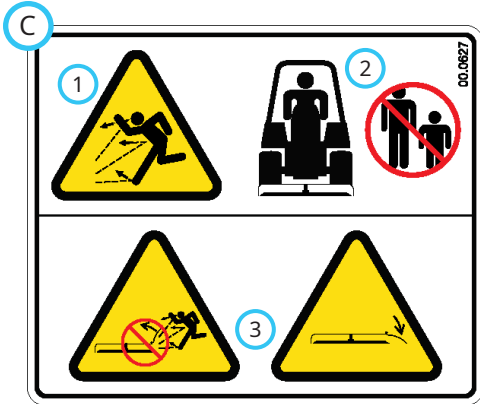

1. Thrown object hazard.
2. Keep bystanders away from the machine.
3. Do not operate with the deflector belting removed.

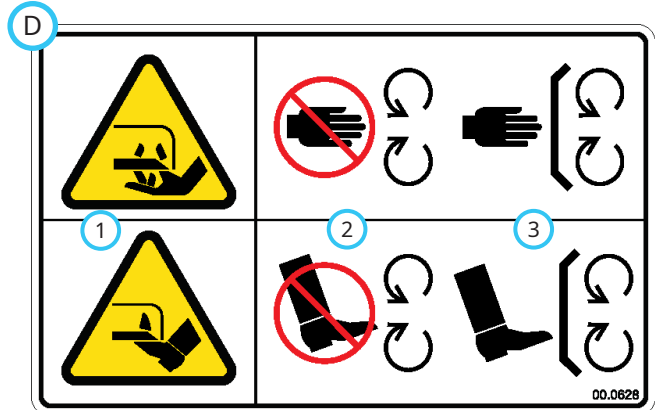

1. Cutting or dismemberment hazard of hand or foot - mower blade.
2. Stay away from moving parts.
3. Keep all guards and shields in place.



1. Fingers or hand entanglement.
2. Stay away from moving parts.

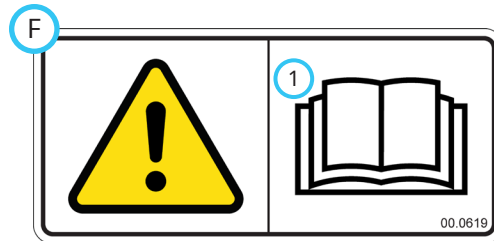

1. Warning - Read the operator's manual.

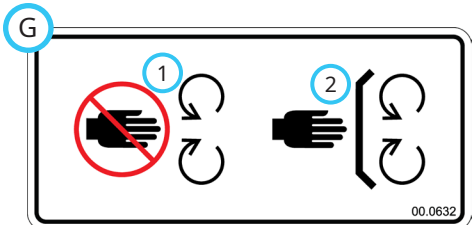

1. Stay away from moving parts.
2. Keep all guards and shields in place.

Decal	Description	Part Number	Quantity
A	Shield Missing	00.0625	1
B	Pinching or Crushing Hazard	00.0620	1
C	Thrown Object Hazard	00.0627	1
D	Cutting Hazard Mower Blade	00.0628	4
E	Finger/Hand Entanglement	00.0631	1
F	Read Operator's Manual	00.0619	1
G	Moving Parts Hazard	00.0632	1

OPERATIONAL CONTROLS

Operational Control Locations

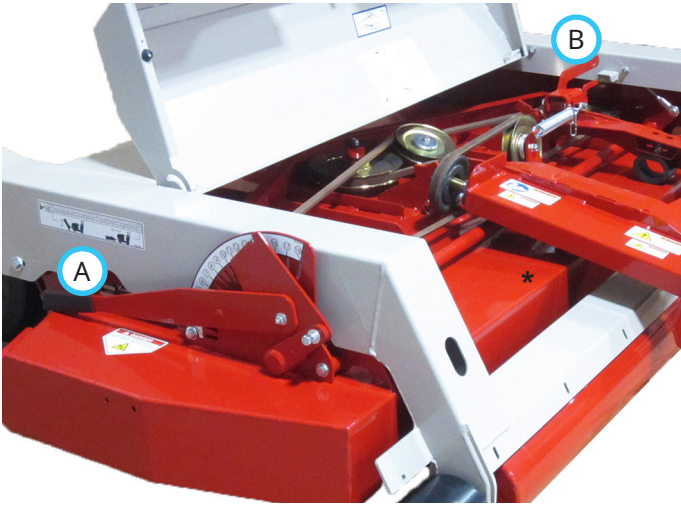

- A. Height Adjustment Handle
- B. Belt Tension Handle

Height Adjustment Handle (A)

The height adjustment handle (A) is used to raise or lower the mower deck and to lock the mower deck at the desired cutting height.

Belt Tension Handle (B)

The belt tension handle (B) is used to release or apply tension to the mower deck belt. The deck belt tension handle must be released in order to flip the deck up to the service position.

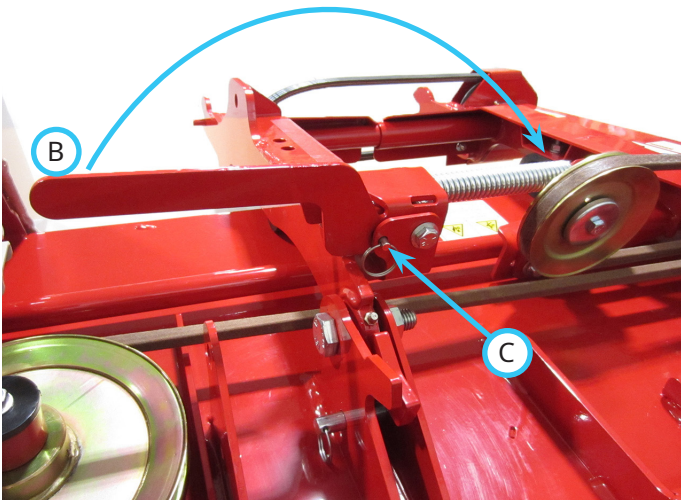

Remove the ball pin (C) from the belt tension handle and rotate the handle 180 degrees to release the belt tension.

Primary SDLA Control Lever

Pull the power unit's primary SDLA lever* to the left to raise the power unit front hitch and mower deck. Push the lever to the right to lower the power unit front hitch and mower deck. The control lever must be in the float (detent) position during operation of the mower. Float position is attained by pushing the lever to the right until the float detent locks the lever in place.

Secondary SDLA Control Lever

The power unit's secondary SDLA control lever* controls the optional hydraulic deck flip up kit. Pull the lever to the left to flip the deck up to the service position. Push the lever to the right to lower the deck back down to the operation position.

Weight Transfer

Terrain and ground conditions may affect the appropriate setting for the power unit's weight transfer system*. In most cases, the weight transfer system should be set from 1/2 to 3/4 of maximum capacity.

*Refer to power unit operator's manual for operation of power unit controls.

GENERAL OPERATION

Daily Inspection

⚠ WARNING

Always engage the parking brake, shut off the power unit engine, remove the ignition key, and ensure that all moving parts have come to a complete stop before inspecting the components, or attempting any repair or adjustment.

1. Park the machine on a level surface, with the engine shut off and all fluids cold.
2. Perform a visual inspection of both the power unit and the attachment. Look for loose or missing hardware, damaged components, or signs of wear.
3. If equipped, inspect the hydraulic hoses and the hydraulic fittings to ensure tight, leak free connections.
4. Inspect the belts for damage or excessive wear. Refer to the Belt Inspection section of this manual.
5. Inspect the mower blades and the mower blade mounting bolts. The blades should be sharp and securely fastened. Service as required.
6. Check the tires for proper inflation.

Attaching

1. Make sure the mower deck height adjustment handle is set to position #18.
2. Drive the power unit slowly forward into the hitch arms of the attachment. Align the lift arms of the power unit with the attachment hitch arms by raising or lowering the front hitch and complete the engagement.
3. Once completely engaged, move the front hitch latch lever* to the locked position. The latch (A) must lock over the attachment's hitch arm pin (B).
4. Engage the parking brake* and shut off the engine.
5. Place the attachment belt onto the PTO drive pulley on the power unit. Ensure the belt is properly seated in each pulley.
6. Engage the PTO belt tensioner rod.
7. If equipped, wipe the hose ends clean and connect to the power unit's hydraulic quick couplers. If equipped, connect the hoses and the quick couplers so the colored indicators are paired together (red to red, etc.).

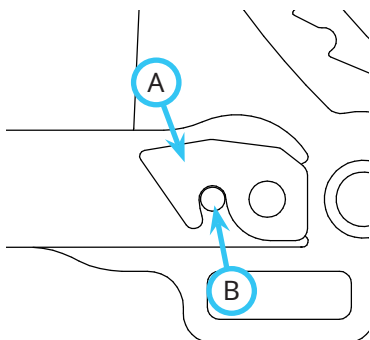

Detaching

1. Park the power unit on a level surface and engage the parking brake.*
2. Place the mower deck height adjustment handle in position #18.
3. Disengage the weight transfer system*.
4. Lower the attachment to the ground.
5. Shut off the power unit engine.
6. Disengage the PTO belt tensioner rod.
7. Remove the attachment belt from the PTO drive pulley of the power unit.
8. If equipped, release hydraulic pressure by moving the secondary SDLA lever to the left and right, then disconnect the hydraulic quick couplers from the power unit and store the hose ends in the top frame holes on the attachment.
9. Disengage the front hitch locking lever.*
10. Restart the power unit and slowly back away from the attachment. A side to side movement of the steering wheel may aid in disengagement.

Operating Procedure

Before operation, perform the daily inspection and confirm the mower deck cutting height and the power unit's weight transfer system are set properly.

Lower the mower deck to the ground and place the power unit's primary SDLA lever in the float position by pushing it to the right until the detent engages. The lever will stay in this position until intentionally removed.

With the engine running between 2,000 and 3,000 rpm, engage the PTO switch. Adjust the throttle to the desired engine RPM.

Begin forward motion in the desired mowing path. Avoid obstacles and remove debris as necessary. When the edge of the mowing area is reached, turn the power unit and mower around and align for the next pass.

Mowing in a back and forth pattern, where each mowing pass is made in the opposite direction of the pass beside it, will create a stripe pattern in the grass. The full length rear roller rolls the grass in the direction of travel to further enhance the stripe effect.

*Refer to power unit operator's manual for operation of power unit controls.

GENERAL OPERATION

Transport of the Attachment

Transport the attachment with the power unit front hitch and attachment fully raised to reduce wear of the equipment. Travel slowly when transporting over undulating and rough surfaces to maintain control of the power unit and to reduce the shock to the power unit and the attachment. Always disengage the power unit PTO before transporting the attachment.

Cutting Height Adjustment

1. Lift the height adjustment handle (A) upward and engage the pin (B) in the notch in the height adjustment plate.

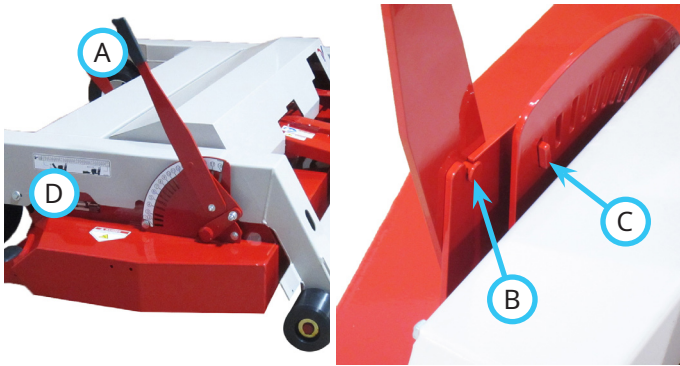

2. Pull the attachment handle outward to release the tab (C) on the height adjustment plate from the slot in the height adjust selector plate.
3. Raise or lower the height adjustment handle to the desired cutting height and insert the tab on the height adjuster plate into the slot on the height adjust selector plate. The decal (D) on the side of the carrier frame lists the cutting height along with the selector plate position number for easy reference.
4. Disengage the pin on the height adjustment handle from the notch in the height adjuster plate and rotate the height adjustment handle down to rest on the main deck.

Front Roller Position

The three front rollers on the mower deck have an upper or lower mounting position. The correct mounting position is dependent on the selected cutting height. To prevent scalping, mount the front rollers in the recommended position. All three front rollers should be mounted in the same position.

If the selected cutting height is 1-3/4" (44mm) or lower, mount the front rollers in the upper mounting hole (A).

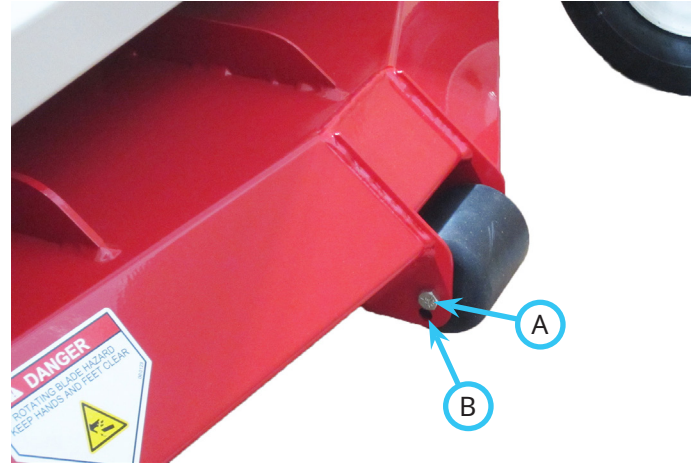

If the selected cutting height is 2" (51 mm) or higher, mount the front rollers in the lower mounting hole (B).

Mulching Kit (Optional Accessory)

Mulching procedures may vary greatly due to climate, type of grass, and soil conditions. It is generally best to mow frequently and in dry conditions. Leaves are usually mulched and dispersed better when some grass is cut with the leaves.

Mulching often requires more power than normal mowing. Reduce travel speed and remove less grass than normal when mulching. When mulching wet and/or thick grass, more frequent cleaning of the underside of the deck may be necessary.

Mulching blades are recommended for mulching. Blades must be kept sharp and in good condition for best results.

SERVICE

⚠ WARNING

Always engage the parking brake, shut off the power unit engine, remove the ignition key, and ensure that all moving parts have come to a complete stop before inspecting the components, or attempting any repair or adjustment.

ATTENTION

If any component requires replacement, use only original Ventrac replacement parts.

Cleaning and General Maintenance

For best results, and to maintain the finish of the mower deck, clean or wash the mower to remove accumulated clippings, leaves, and dirt when the job is finished. Refer to the Deck Flip Up Procedure to access the underside of the deck.

If washing the deck, do not spray directly into bearings or seals. After washing, it is important to run the mower so that water does not reside on seals of bearings for the drive system. When washing is complete, return the deck to the operating position. Move the power unit and mower to a clean debris-free location and activate the PTO for 30 seconds to remove any standing water.

Main Deck Cover Shield Removal and Installation

1. Open the main deck cover shield.
2. Push the shield to the right until the left pin clears the carrier frame.

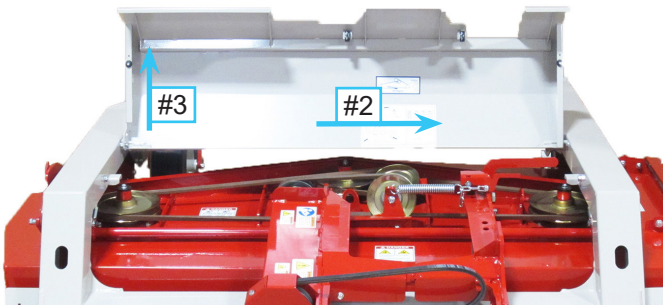

3. Lift the left side of the cover up, then slide to the left to remove the right pin from the carrier frame.
4. Place the shield in a location where it will not get scratched or damaged.

5. To reinstall the cover, insert the right pin into the hole in the right carrier frame arm.
6. Push against the spring tension until the left pin clears the left carrier frame arm.
7. Lower the left side of the cover until the pin can be inserted into the hole in the left carrier frame arm. Note: the bolt in the carrier frame must engage in the radial slot in the end of the cover.

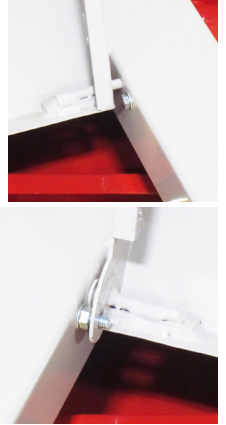

Deck Flip Up Procedure (Service Position) Manual Flip Up Procedure

1. Park the power unit on a smooth level surface.
2. Engage the parking brake, shut off the engine, and remove the ignition key.
3. Place the mower deck height adjustment handle into position #1.
4. Open the main deck cover shield.
5. Remove the ball pin from the belt tensioner handle and rotate the handle 180 degrees to release the belt tension.
6. Remove the two ball pins (A) from the left and right hitch arm mounting brackets.

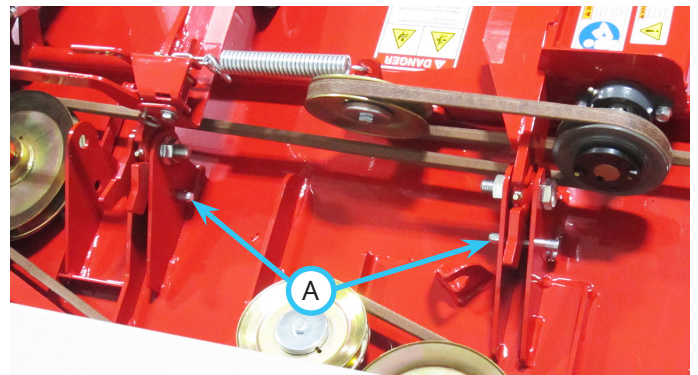

7. Close the main deck cover shield.
8. Start the power unit's engine and raise the power unit front hitch to its highest position.

SERVICE

9. Lift the mower deck up to a near vertical position and reinstall the two ball pins (B) to lock the deck in the upright position.

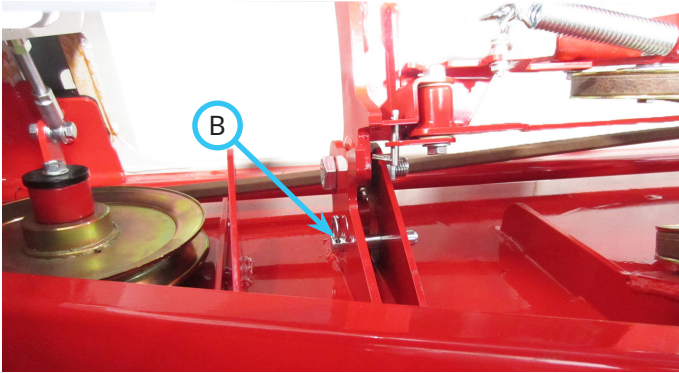

10. To return the deck to the operating position, remove the two ball pins and rotate the deck to the operating position. NOTE: if the front hitch lowers due to hydraulic drift, it may be necessary to start the engine and raise the mower deck before removing the ball pins.

11. Lower the mower deck to the ground.
12. Reinstall the two ball pins in the hitch arm mounting brackets.
13. Ensure the belt is properly seated in the pulley grooves, rotate the belt tensioner handle 180 degrees to engage belt tension, and secure with the ball pin.

Optional Hydraulic Flip Up Procedure

1. Park the power unit on a smooth level surface.
2. Engage the parking brake, shut off the engine, and remove the ignition key.
3. Place the mower deck height adjustment handle into position #1.
4. Open the main deck cover shield.
5. Remove the ball pin from the belt tensioner handle and rotate the handle 180 degrees to release the belt tension and release the cylinder lock bracket.
6. Remove the two ball pins (A) from the left and right hitch arm mounting brackets.

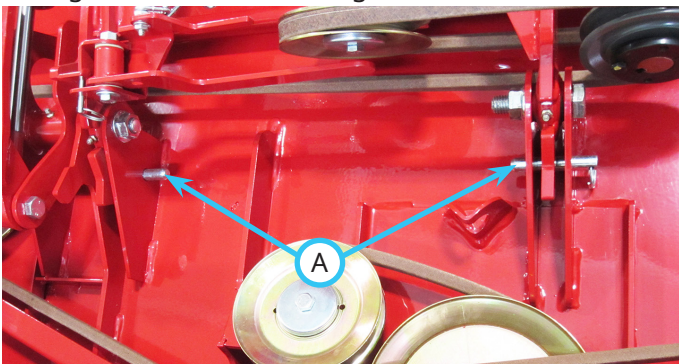

7. Close the main deck cover shield.
8. Return to the operator's seat, start the power unit's engine, and raise the power unit front hitch to its highest position.
9. Pull the secondary SDLA lever to the left and hold until the deck stops moving at a near vertical position. NOTE: it may be necessary to operate the power unit engine at maximum RPM when flipping the deck up.
10. Shut off the power unit engine and remove the key from the ignition.

11. Reinstall the two ball pins (B) to lock the deck in the upright position. NOTE: you may need to push the top of the deck back slightly to install the pins.

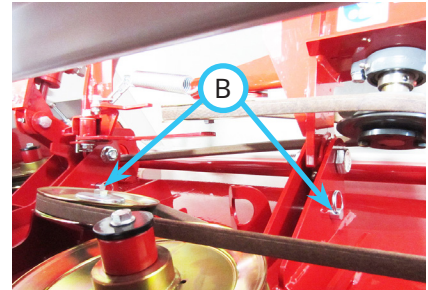

12. To return the deck to the operating position, remove the two ball pins, return to the power unit's seat, start the power unit engine, and lower the deck to the operating position by pushing the secondary SDLA lever to the right. NOTE: if the front hitch lowers due to hydraulic drift, it may be necessary to start the engine and raise the mower deck before removing the ball pins.
13. Lower the mower deck to the ground.
14. Shut off the power unit engine and remove the key from the ignition switch.
15. Reinstall the two ball pins in the hitch arm mounting brackets.
16. Ensure the belt is properly seated in the pulley grooves, rotate the belt tensioner handle 180 degrees to engage belt tension, and secure with the ball pin.

SERVICE

Mower Blade Inspection/Replacement

⚠ CAUTION

Mower blades may be sharp. Always wear heavy gloves when working with mower blades.

1. Rotate the mower deck up to the service position.
2. Inspect the mower blades to ensure the cutting edges are sharp. If blades are dull or damaged, they must be removed and sharpened or replaced.
3. Place a short piece of 2 x 4 wood between the end of the blade and an appropriate structural part of the deck frame to prevent the blade from rotating.
4. Loosen the blade bolt counterclockwise and remove the blade for sharpening or replacement.
5. When installing a blade, the wood block must be placed on the opposite side of the blade to prevent blade rotation when tightening the blade bolt.
6. Torque the blade bolt to 136 Nm (100 ft-lbs).

Mower Blade Sharpening

Mower blades should be sharpened and balanced by a professional. Maintain the balance, the same bevel, and the length of the sharpened surface.

Belt Inspection

Inspecting the drive belts of the attachment can prevent sudden belt failure by finding problems before they cause a belt to break.

Typical wear on a drive belt may result in the conditions shown in the diagram. If any of these conditions

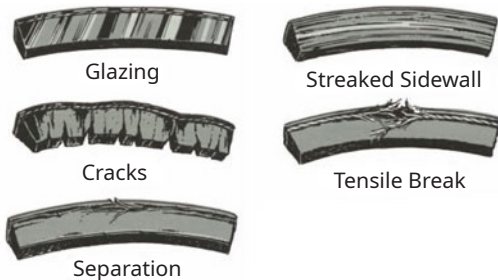

occur, the drive belt will require replacement.

Attachment Belt Replacement

1. Detach the mower deck from the power unit.
2. Remove the drive pulley shield (A).
3. Remove the old drive belt and install the new drive belt onto the pulley.
4. Reinstall the drive pulley shield.

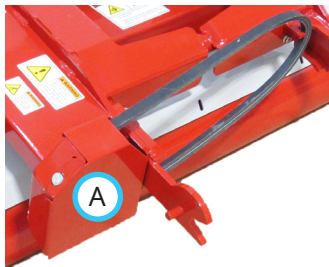

Deck Belt Replacement

1. Detach the mower deck from the power unit.
2. Open the main deck cover shield.
3. Remove the ball pin from the belt tensioner handle and rotate the handle up to release the belt tension.
4. Remove the belt from the belt tensioner pulley and slide the loop of the deck belt over the end of the left hitch arm so that the belt is looped around the left hitch arm mounting brackets.



5. Remove the left hitch arm mounting bolt and lift the hitch arm up away from the mounting brackets.

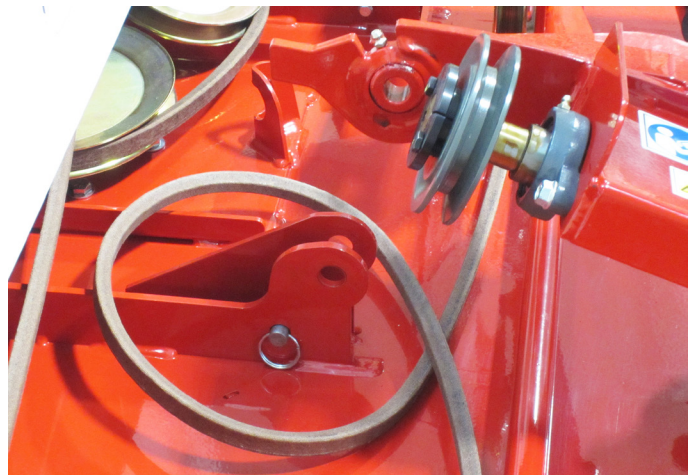

6. Pull the deck belt out through the opening between the hitch arm and the mounting brackets.
7. Remove the belt from the spindle pulleys, lift up slightly on the left and right hitch arms so the rear loop of the belt clears the hitch arm bumpers, and remove the belt from around the hitch arms.

SERVICE

- Place the new belt over the hitch arms. The front of the belt loop goes above the hitch arms and is installed on the spindle pulleys. The rear of the belt loop goes under the hitch arms.

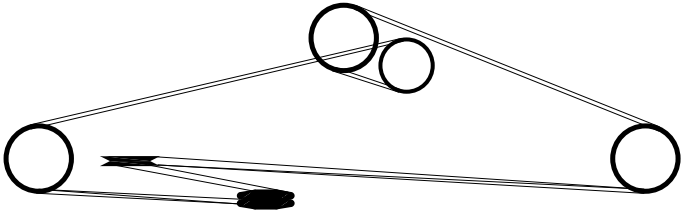

- Lift the front of the left hitch arm up away from the mounting brackets and loop the belt around the left hitch arm mounting brackets as shown in the previous pictures.
- Reinstall the left hitch arm bolt and nut and torque to 205 Nm (151 ft-lbs).
- Place the belt loop onto the drive shaft pulley and the belt tensioner pulley.
- Check to ensure the belt is routed properly and seated in the groove of each pulley.
- Rotate the belt tensioner handle 180 degrees to engage belt tension and secure with the ball pin.

Deck Belt Tension Adjustment

If the deck belt slips during normal mowing operation, the belt tension will need to be adjusted.

- Open the main deck cover shield.
- Remove the ball pin from the belt tensioner handle and rotate the handle 180 degrees to release the belt tension.
- Move the extension spring hook (A) into the next chain link (B) closer to the belt tensioner handle.

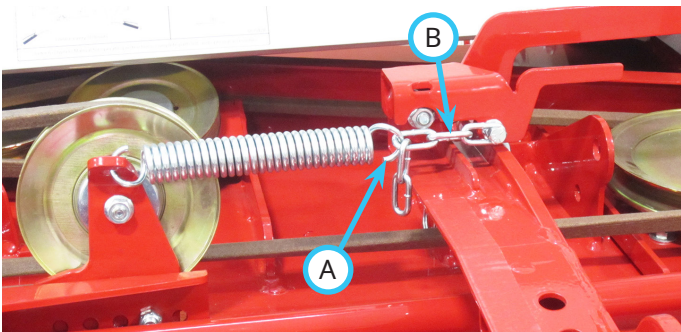

- Rotate the belt tensioner handle down to engage belt tension and secure with the ball pin.
- Close the main deck cover shield.

Deck Leveling Procedure

⚠ CAUTION

Mower blades may be sharp. Always wear heavy gloves when working with mower blades.

- Place the mower deck on a hard surface that is clean and level.
- Place the mower deck height adjustment handle into position #18.
- Ensure both front tires are inflated to the recommended tire pressure.
- Block the tires and rear roller to prevent the mower deck from rolling during leveling procedure.
- Check the mower blades to make sure they are not bent.
- Starting at either side of the mower deck, turn the blade so the cutting tip is at the back of the deck. Measure the distance from the flat surface to the blade tip.



- Move to the opposite side of the mower deck and turn that blade so the cutting tip is at the back of the deck. If this distance measures differently from the first side, adjust the height adjustment linkage (A) directly above on the top side of the deck until the measurement is the same as the first side.

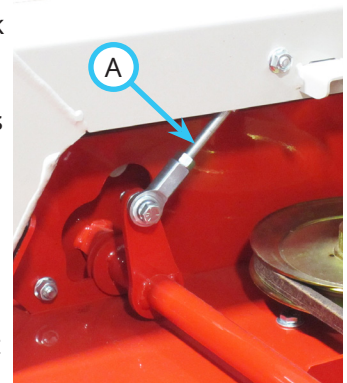

SERVICE

- Once the deck has been leveled side to side, rotate the same blade tip to the front of the deck and measure. The blade tip should be level to 3 mm (1/8 inch) lower at the front. If the measurement at the front of the deck is higher or more than 3 mm (1/8 inch) lower, the deck must be leveled.
- To adjust the front of the deck, loosen the cross bolts (B) in the carrier frame.

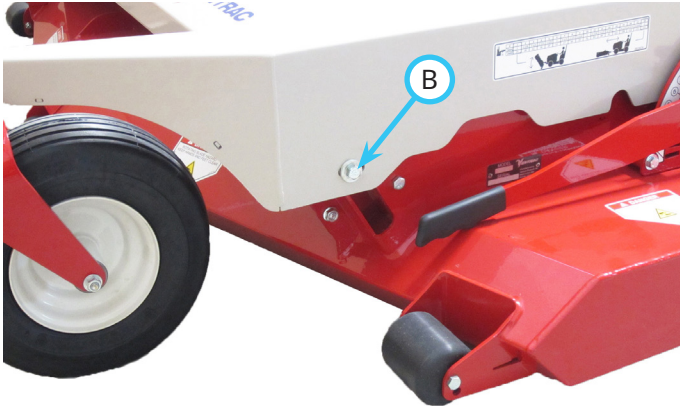

Move the bolts forward in the slots to lower the deck or move the bolts rearward in the slots to raise the deck. **Note:** slight movement of the bolt in the front carrier slots will make a significant difference in the front deck height.

- After deck has been leveled, make sure the cross bolts in the carrier frame have been tightened and the nuts on the rear height adjustment links have been locked against the rod ends.

Tire Pressure

Tire pressure should be maintained between 8-10 psi (55-69 kPa). Pressure variance between the left and right tires can cause an uneven cut.

Lubrication Locations

Lubrication is required at the following locations using a lithium complex NLGI #2 grease.

Wipe the grease fittings clean before applying grease to the grease fittings.

Refer to the maintenance schedule for service intervals and the amount of grease.

- Rotate the mower deck up to the service position.
- Grease the three spindles and the right rear roller bearing.

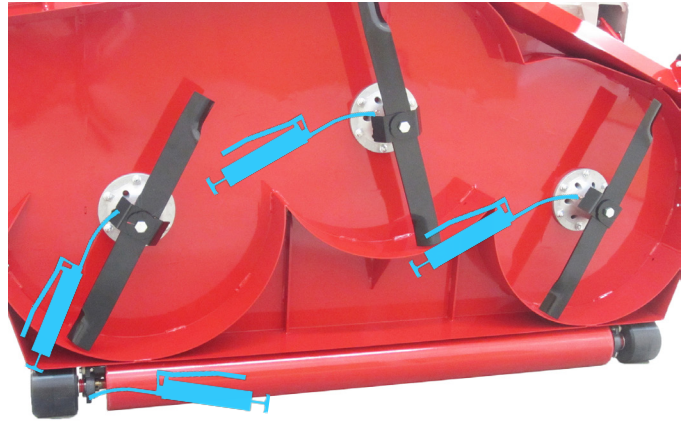

- If the mower deck is equipped with a hydraulic flip up kit, grease the flip up rocker bracket.

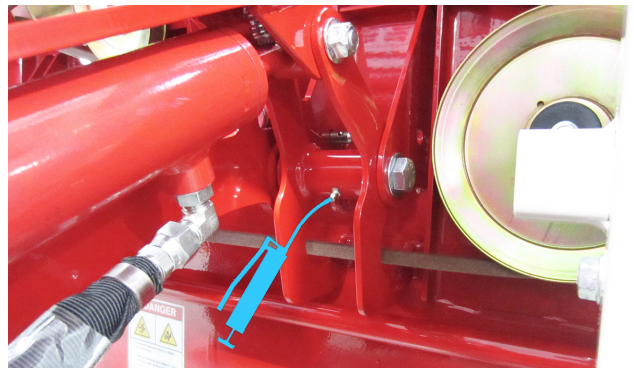

- Return the deck to the operating position and lower the deck to the ground.
- Grease the left rear roller bearing, the left and right caster wheel pivots, and the left and right wheel axles.

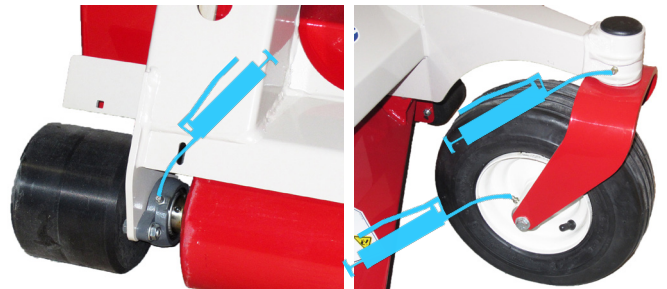

SERVICE

- Grease the drive shaft bearings and the hitch arm pivots. Wipe off any excess grease.

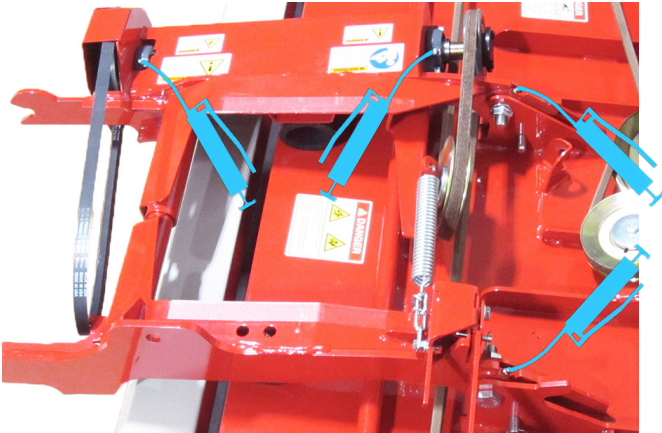

- Place the mower deck height adjustment handle into position #18.
- Clean and apply grease to the back of the rear carrier frame/mower deck slide plates through the access holes (A) in the carrier frame.

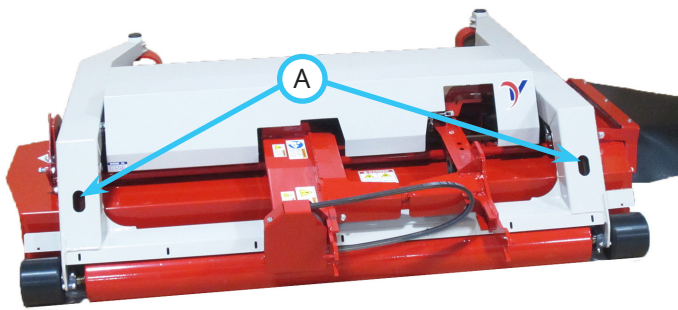

- Place the mower deck height adjustment handle into position #1 and open the main deck cover shield.
- Clean and apply grease to the front side of the rear carrier frame/mower deck slide plates (B).

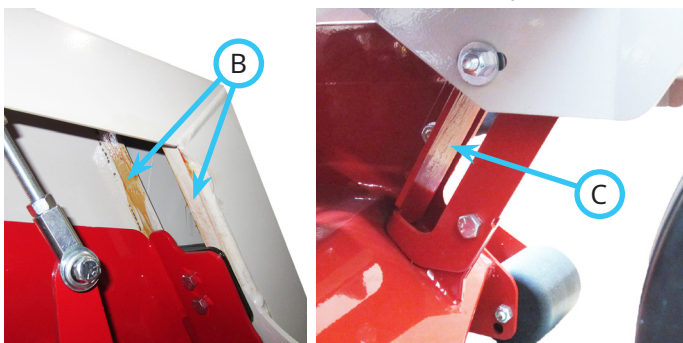

- Clean and apply grease to the back face of the front carrier frame/mower deck slide plates (C).

- If the mower deck is equipped with a hydraulic flip up kit, grease the cylinder ends. Wipe off any excess grease.

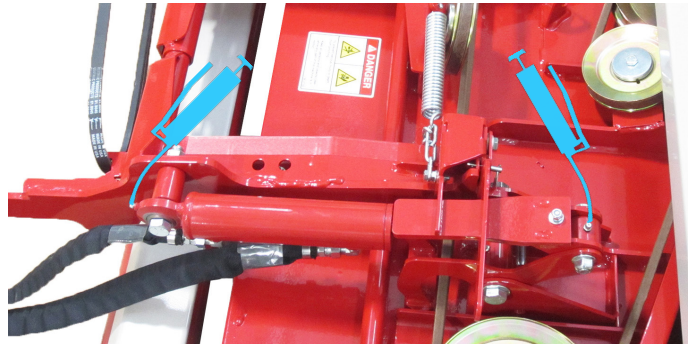

Storage

Preparing the Attachment for Storage

- Clean the mower deck and frame.
- Inspect for loose or missing hardware, damaged components, or signs of wear. Repair or replace any damaged or worn components.
- Inspect the belts, the spindles, and the mower blades. Repair or replace any damaged or worn components.
- Inspect the safety decals. Replace any decals that are faded, illegible, or missing.
- Apply grease to all grease points and wipe off any excess grease.
- If the mower deck is equipped with a hydraulic flip up kit, inspect the hydraulic hoses for damage or wear. Inspect the hydraulic hoses and fittings to ensure tight, leak-free connections.
- Inspect the painted components for chips, scratches, or rust. Clean and touch up the surfaces as needed.

Removing the Attachment from Storage

- Clean the attachment to remove any accumulated dust or debris.
- Inspect the attachment as instructed in the Daily Inspection section of this manual.
- Test the attachment to ensure that all the components are working properly.

SERVICE

Maintenance Schedule

	# of locations	# of pumps	As Needed	Daily	At 50 hours	At 100 hours	At 150 hours	At 200 hours	At 250 hours	At 300 hours	At 350 hours	At 400 hours	At 450 hours	At 500 hours	At 550 hours	At 600 hours	At 650 hours	At 700 hours	At 750 hours	At 800 hours	At 850 hours	At 900 hours	At 950 hours	At 1,000 hours	Yearly	
Grease and Lubrication: See Lubrication Section																										
Caster Wheel Pivot	2	1			✓	✓	✓	✓	✓	✓	✓	✓	✓	✓	✓	✓	✓	✓	✓	✓	✓	✓	✓	✓	✓	
Wheel Axle Bearing	2	^	**		✓	✓	✓	✓	✓	✓	✓	✓	✓	✓	✓	✓	✓	✓	✓	✓	✓	✓	✓	✓	✓	
Rear Roller Bearing	2	1			✓	✓	✓	✓	✓	✓	✓	✓	✓	✓	✓	✓	✓	✓	✓	✓	✓	✓	✓	✓	✓	
Jack Shaft Bearing	2	1			✓	✓	✓	✓	✓	✓	✓	✓	✓	✓	✓	✓	✓	✓	✓	✓	✓	✓	✓	✓	✓	
Spindle	3	3			✓	✓	✓	✓	✓	✓	✓	✓	✓	✓	✓	✓	✓	✓	✓	✓	✓	✓	✓	✓	✓	
Hitch Arm Pivot	2	^			✓	✓	✓	✓	✓	✓	✓	✓	✓	✓	✓	✓	✓	✓	✓	✓	✓	✓	✓	✓	✓	
Deck Slide	4	%	**		✓	✓	✓	✓	✓	✓	✓	✓	✓	✓	✓	✓	✓	✓	✓	✓	✓	✓	✓	✓	✓	
Hydraulic Flip Up Cylinder Ends	2	^			✓	✓	✓	✓	✓	✓	✓	✓	✓	✓	✓	✓	✓	✓	✓	✓	✓	✓	✓	✓	✓	
Hydraulic Flip Up Rocker Bracket	1	^			✓	✓	✓	✓	✓	✓	✓	✓	✓	✓	✓	✓	✓	✓	✓	✓	✓	✓	✓	✓	✓	
Inspection																										
Inspect for Loose, Missing, or Worn Components				✓																						
Check Tire Pressure				✓																						
Inspect the Belts and Pulleys				✓																						
Inspect the Blades and Blade Mounting Bolts (Torque to 136 Nm (100 ft-lbs))				✓																						
Check the Hitch Pivot Bolts (Torque to 205 Nm (151 ft-lbs))					✓		✓			✓		✓		✓		✓		✓		✓		✓		✓		
Inspect the Safety Decals				✓																						
^ Grease until fresh grease is visible.																										
** Operation in severe conditions may require more frequent service intervals.																										
% Clean and relubricate with a thin film of grease.																										

SERVICE

Maintenance Checklist

	# of locations	# of pumps	As Needed	Daily	At 50 hours	At 100 hours	At 150 hours	At 200 hours	At 250 hours	At 300 hours	At 350 hours	At 400 hours	At 450 hours	At 500 hours	At 550 hours	At 600 hours	At 650 hours	At 700 hours	At 750 hours	At 800 hours	At 850 hours	At 900 hours	At 950 hours	At 1,000 hours	Yearly
Grease and Lubrication: See Lubrication Section																									
Caster Wheel Pivot	2	1																							
Wheel Axle Bearing	2	^	**																						
Rear Roller Bearing	2	1																							
Jack Shaft Bearing	2	1																							
Spindle	3	3																							
Hitch Arm Pivot	2	^																							
Deck Slide	4	%	**																						
Hydraulic Flip Up Cylinder Ends	2	^																							
Hydraulic Flip Up Rocker Bracket	1	^																							
Inspection																									
Inspect for Loose, Missing, or Worn Components																									
Check Tire Pressure																									
Inspect the Belts and Pulleys																									
Inspect the Blades and Blade Mounting Bolts (Torque to 136 Nm (100 ft-lbs))																									
Check the Hitch Pivot Bolts (Torque to 205 Nm (151 ft-lbs))																									
Inspect the Safety Decals																									
^ Grease until fresh grease is visible.																									
** Operation in severe conditions may require more frequent service intervals.																									
% Clean and relubricate with a thin film of grease.																									

SPECIFICATIONS

Dimensions

Overall Height	46.4 cm (18-1/4 inches)
Overall Length	168 cm (66-1/8 inches)
Overall Width	220 cm (86-1/2 inches)
Weight	249 kg (550 pounds)
Cutting Width	183 cm (72 inches)
Cutting Height Range	2.54 - 12.7 cm (1 - 5 inches)
Cutting Positions	18

Features

- Flip up deck design
- Offset deck - 16.5 cm (6-1/2 inches) to the left
- Three front anti-scalp rollers
- Full length rear roller for even cutting and striping
- Single lever linear height adjustment system
- Full floating deck
- Field serviceable spindles