

Operator's Manual

HQ680

Tough Cut Mower
Serial Number HQ680-AD1902 --





View all manuals



500 Venture Drive
Orrville Oh 44667
www.ventrac.com

Visit ventrac.com/manuals for the latest version of this operator's manual. A downloadable parts manual is also available.

To the Owner Contact Information and Product Identification

If you need to contact an authorized Ventrac dealer for information on servicing your product, always provide the product model and serial numbers.

Please fill in the following information for future reference. See the picture(s) below to find the location of the identification numbers. Record them in the spaces provided.

Date of Purchase: _____

Dealer: _____

Dealer Address: _____

Dealer Phone Number: _____

Dealer Fax Number: _____

Model # (A): _____ Serial # (B): _____ Affix Part/Serial Number label here.

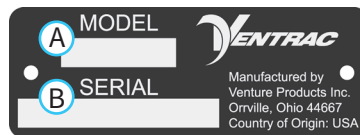

Ventrac Products Inc. reserves the right to make changes in design or specifications without obligation to make like changes on previously manufactured products.

TABLE OF CONTENTS

INTRODUCTION	PAGE 5
Product Description	5
Why Do I Need an Operator's Manual?	5
Using Your Manual.	6
Manual Glossary	6
SAFETY	PAGE 7
General Safety Procedures.	7
Training Required	7
Requirements for Personal Protective Equipment (PPE)	7
Operation Safety.	7
Keep Riders Off.	9
Operating On Slopes	9
Roadway Safety	10
Truck Or Trailer Transport	10
Maintenance	10
Fuel Safety	11
Hydraulic Safety	12
Cutting Unit Safety	13
Safety Decals	14
OPERATIONAL CONTROLS	PAGE 16
Jack Stand	16
Primary SDLA Control Lever.	16
Weight Transfer	16
GENERAL OPERATION	PAGE 17
Daily Inspection	17
Attaching	17
Detaching	17
Mowing and Operating Procedure	17
Transport of Mower	18
Cutting Height Adjustment	18
(Standard Wheels).	18
Cutting Height Adjustment	18
(Optional Swivel Wheels)	18

TABLE OF CONTENTS

SERVICE	PAGE 19
Cleaning and General Maintenance	19
Deck Flip-Up Procedure (Service Position)	19
Mower Blade Inspection/Replacement	20
Mower Blade Sharpening	20
Belt Inspection	20
Attachment Drive Belt Replacement.	20
Main Deck Belt Replacement	21
Right Deck Belt Replacement	22
Main Deck Belt Tension Adjustment	22
Lubrication Locations.	23
Deck Leveling Procedure.	23
Storage	24
Maintenance Schedule	25
Maintenance Checklist	25
SPECIFICATIONS	PAGE 26
Dimensions	26
Features	26
WARRANTY	PAGE 27

INTRODUCTION



Ventrac Products Inc. is pleased to provide you with your new Ventrac tough cut mower! We hope that Ventrac equipment will provide you with a ONE Tractor Solution.

Listed below are just some of the items that can provide you versatility as you use your HQ680 tough cut mower. Please visit our website, or contact your authorized Ventrac dealer for a complete list of items available for your new mower.

Accessories	Item Description	Part Number
	HQ680 Swivel Wheel Kit	70.8213

Product Description

The HQ680 tough cut mower is designed for mowing high grass, thick weeds, and brush. A large baffled front opening allows brush to enter for cutting and hinders debris from escaping.

Three heavy duty blades counter rotate to cut and drop materials evenly without windrowing. Capable of cutting material up to 2-1/2 cm (1 inch) in diameter, the HQ680 mower makes short work out of heavy brush.

The HQ680 tough cut mower can be set to three different cutting heights of 76, 92, or 108 mm (3, 3-5/8, or 4-1/4 inches). The optional swivel wheel kit provides eight different cutting heights ranging from 89 to 178 mm (3-1/2 to 7 inches).

The HQ680 can be tilted up to access the underside of the deck for cleaning, maintenance, or storage.

Why Do I Need an Operator's Manual?

This manual has been created to help you gain the important knowledge of what is needed to safely operate, maintain, and service your machine. It is divided into sections for convenient reference of the appropriate section.

You must read and understand the operator's manual for each piece of Ventrac equipment you own. Reading the operator's manual will help you become familiar with each specific piece of equipment. Understanding the operator's manual will help you, as well as others, avoid personal injury and/or damage to the equipment. Keep this manual with the machine at all times. The manual should remain with the machine even if it is sold. If this manual becomes damaged or unreadable, it should be replaced immediately. Contact your local Ventrac dealer for a replacement.

When using a Ventrac attachment, be sure to read and follow the safety and operating instructions of both the power unit and the attachment being used to ensure the safest operation possible.

The information in this manual provides the operator with the safest procedures to operate the machine while getting the maximum use out of the unit. Failure to follow the safety precautions listed in this manual may result in personal injury and/or damage to the equipment.

INTRODUCTION

Using Your Manual

Throughout this manual, you will encounter special messages and symbols that identify potential safety concerns to help you as well as others avoid personal injury or damage to the equipment.

SYMBOL DEFINITIONS

ATTENTION

 This symbol identifies potential health and safety hazards. It marks safety precautions. Your safety and the safety of others is involved.

There are three signal words that describe the level of safety concern: Danger, Warning, and Caution. Safety should always be the #1 priority when working on or operating equipment. Accidents are more likely to occur when proper operating procedures are not followed or inexperienced operators are involved.

Note: Right-Hand and Left-Hand orientations may be referred to at different places throughout this manual. Right-Hand and Left-Hand is determined as if facing forward from the operator station.

SIGNAL WORD DEFINITIONS

DANGER

Indicates an imminently hazardous situation which, if not avoided, will result in death or serious injury. This signal word is limited to the most extreme cases.

WARNING

Indicates a potentially hazardous situation which, if not avoided, could result in death or serious injury.

CAUTION

Indicates a potentially hazardous situation which, if not avoided, may result in minor or moderate injury and/or property damage. It may also be used to alert against unsafe practices.

Manual Glossary

- Power Unit** A Ventrac tractor or other Ventrac engine powered device that may be operated by itself or with an attachment or accessory.
- Attachment** A piece of Ventrac equipment that requires a Power Unit for operation.
- Accessory** A device that attaches to a Power Unit or Attachment to extend its capabilities.
- Machine** Describes any “Attachment” or “Accessory” that is used in conjunction with a power unit.

SAFETY



General Safety Procedures for Ventrac Power Units, Attachments, & Accessories



Training Required

- The owner of this machine is solely responsible for properly training the operators.
- The owner/operator is solely responsible for the operation of this machine and for the prevention of accidents or injuries occurring to him/herself, other people, or property.
- Do not allow operation or service by children or untrained personnel. Local regulations may restrict the age of the operator.
- Before operating this machine, read the operator's manual and understand its contents.
- If the operator of the machine cannot understand this manual, then it is the responsibility of this machine's owner to fully explain the material within this manual to the operator.
- Learn and understand the use of all the controls.
- Know how to stop the power unit and the attachments quickly in the event of an emergency.

Requirements for Personal Protective Equipment (PPE)

- The owner is responsible for ensuring that all the operators use the proper PPE while operating the machine. Whenever you use the machine, use the following PPE:
- Certified eye protection and hearing protection.
- Closed toe, slip resistant footwear.
- Long pants or trousers.
- A dust mask for dusty conditions.

Operation Safety

- Inspect the machine before operation. Repair or replace any damaged, worn, or missing parts. Be sure the guards and shields are in proper working condition and are secured in place. Make any necessary adjustments before operating the machine.
- Some pictures in this manual may show shields or covers opened or removed in order to clearly illustrate the instructions. Under no circumstance should the machine be operated without these devices in place.
- Alterations or modifications to this machine can reduce safety and could cause damage to the machine. Do not alter the safety devices or operate with the shields or covers removed.
- Before each use, verify that all the controls function properly and inspect all the safety devices. Do not operate if the controls or safety devices are not in proper working condition.
- Check the parking brake function before operating. Repair or adjust the parking brake if necessary.
- Observe and follow all of the safety decals.
- All the controls are to be operated from the operator's station only.
- Always wear a seat belt if the machine has a roll cage/bar installed and in the upright position.
- Ensure the attachment or accessory is locked or fastened securely to the power unit before operating.

SAFETY



General Safety Procedures for Ventrac Power Units, Attachments, & Accessories



- Ensure that all bystanders are clear of the power unit and the attachment before operating. Stop the machine if someone enters your work area.
- Always be alert to what is happening around you, but do not lose focus on the task you are performing. Always look in the direction the machine is moving.
- Look behind and down before backing up to be sure of a clear path.
- If you hit an object, stop and inspect the machine. Make any necessary repairs before operating the machine again.
- Stop operation immediately at any sign of equipment failure. An unusual noise can be a warning of equipment failure or a sign that maintenance is required. Make any necessary repairs before operating the machine again.
- If equipped with a high/low range feature, never shift between high and low range while on a slope. Always move the machine to level ground and engage the parking brake before shifting range.
- Do not leave the machine unattended while it is running.
- Always park the machine on level ground.
- Always shut off the engine when connecting the attachment drive belt to the power unit.
- Never leave the operator's station without lowering the attachment to the ground, engaging the parking brake, shutting off the engine, and removing the ignition key. Make sure all moving parts have come to a complete stop before dismounting.
- Never leave the machine unattended without lowering the attachment to the ground, engaging the parking brake, shutting off the engine, and removing the ignition key.
- Only operate in well-lit conditions.
- Do not operate when there is a risk of lightning.
- Never direct the discharge of any attachment in the direction of people, buildings, animals, vehicles, or other objects of value.
- Never discharge material against a wall or obstruction. The material may ricochet back toward the operator.
- Use extra caution when approaching blind corners, shrubs, trees, or other objects that may obscure your vision.
- Do not run the engine in a building without adequate ventilation.
- Do not touch the engine or the muffler while the engine is running or immediately after stopping the engine. These areas may be hot enough to cause a burn.
- Do not change the engine governor settings or over-speed the engine. Operating the engine at excessive speeds may increase the hazard of personal injury.
- To reduce the hazard of fire, keep the battery compartment, engine, and muffler areas free of grass, leaves, excessive grease, and other flammable materials.
- Secure long hair and loose clothing. Do not wear jewelry.
- Clear the working area of objects that might be hit or thrown from the machine.
- Keep people and pets out of the working area.

SAFETY



General Safety Procedures for Ventrac Power Units, Attachments, & Accessories



- Know the work area well before operation. Do not operate where traction or stability is questionable.
- Reduce speed when you are operating over rough ground.
- Equipment can cause serious injury and/or death when improperly used. Before operating, know and understand the operation and safety of the power unit and the attachment being used.
- Do not operate the machine if you are not in good physical and mental health, if you will be distracted by personal devices, or if you are under the influence of any substance which might impair your decisions, dexterity, or judgment.
- Children are attracted to machine activity. Be aware of children and do not allow them in the work area. Turn off the machine if a child enters the work area.

Keep Riders Off

- Only allow the operator on the power unit. Keep riders off.
- Never allow riders on any attachment or accessory.

Operating On Slopes

- Slopes can cause loss-of-control and tip-over accidents, which can result in severe injury or death. Be familiar with the emergency parking brake, along with the power unit controls and their functions.
- If the power unit is equipped with a fold down roll bar, it must be locked in the upright position when operating on any slope.
- Use low range (if equipped) when operating on slopes greater than 15 degrees.
- Do not stop or start suddenly when operating on slopes.
- Never shift between high and low range while on a slope. Always move the power unit to level ground and engage the parking brake before shifting range or placing the power unit in neutral.
- Variables such as wet surfaces and loose ground will reduce the degree of safety. Do not drive where the machine could lose traction or tip over.
- Keep alert for hidden hazards in the terrain.
- Stay away from drop-offs, ditches, and embankments.
- Sharp turns should be avoided when operating on slopes.
- Pulling loads on hills decreases safety. It is the responsibility of the owner/operator to determine loads that can safely be controlled on slopes.
- Transport the machine with the attachment lowered or close to the ground to improve stability.
- While operating on slopes, drive in an up and down direction whenever possible. If turning is necessary while driving across slopes, reduce your speed and turn slowly in the downhill direction.
- Ensure a sufficient supply of fuel for continuous operation. A minimum of one-half tank of fuel is recommended.

SAFETY



General Safety Procedures for Ventrac Power Units, Attachments, & Accessories



Roadway Safety

- Operate with safety lights when operating on or near roadways.
- Obey all state and local laws concerning operation on roadways.
- Slow down and be careful of traffic when operating near or crossing roadways. Stop before crossing roads or sidewalks. Use care when approaching areas or objects that may obscure vision.
- If there is any doubt of safety conditions, discontinue the machine operation until a time when the operation can be performed safely.
- When operating near or on roadways, have a Slow Moving Vehicle Emblem clearly displayed.

Truck Or Trailer Transport

- Use care when loading or unloading the machine into a truck or trailer.
- Use full width ramps for loading the machine into a truck or trailer.
- The parking brake is not sufficient to lock the machine during transport. Always secure the power unit and/or attachment to the transporting vehicle securely using straps, chains, cables, or ropes. Both the front and rear straps should be directed down and outward from the machine.
- Shut off the fuel supply to the power unit during transport on a truck or trailer.
- If equipped, turn the battery disconnect switch to the Off position to shut off electrical power.

Maintenance

- Keep the safety decals legible. Remove all grease, dirt, and debris from the safety decals and instructional labels.
- If any decals are faded, illegible, or missing, contact your dealer promptly for replacements.
- When new components are installed, be sure that the current safety decals are affixed to the replacement components.
- If any component requires replacement, use only original Ventrac replacement parts.
- Always turn the battery disconnect to the Off position or disconnect the battery before performing any repairs. Disconnect the negative terminal first and the positive terminal last. Reconnect the positive terminal first and the negative terminal last.
- Keep all bolts, nuts, screws, and other fasteners properly tightened.
- Always lower the attachment to the ground, engage the parking brake, shut off the engine, and remove the ignition key. Make sure all moving parts have come to a complete stop before cleaning, inspecting, adjusting, or repairing.
- If the power unit, attachment, or accessory requires repairs or adjustments not instructed in the operator's manual, the power unit, attachment, or accessory must be taken to an authorized Ventrac dealer for service.
- Never perform maintenance on the power unit and/or attachment if someone is in the operator's station.
- Always use protective glasses when handling the battery.

SAFETY



General Safety Procedures for Ventrac Power Units, Attachments, & Accessories



- Check the fuel lines for tightness and wear on a regular basis. Tighten or repair them as needed.
- To reduce the hazard of fire, keep the battery compartment, engine, and muffler areas free of grass, leaves, and excess grease.
- Do not touch the engine, the muffler, or other exhaust components while the engine is running or immediately after stopping the engine. These areas may be hot enough to cause a burn.
- Allow the engine to cool before storing and do not store near an open flame.
- Do not change the engine governor settings or over-speed the engine. Operating engine at excessive speeds may increase the hazard of personal injury.
- Springs may contain stored energy. Use caution when disengaging or removing springs and/or spring loaded components.
- An obstruction or blockage in a drive system or moving/rotating parts may cause a buildup of stored energy. When the obstruction or blockage is removed, the drive system or moving/rotating parts may move suddenly. Do not attempt to remove an obstruction or blockage with your hands. Keep your hands, feet, and clothing away from all power-driven parts.

Fuel Safety

- To avoid personal injury or property damage, use extreme care in handling gasoline. Gasoline is extremely flammable and the vapors are explosive.
- Do not refuel the machine while smoking or at a location near flames or sparks.
- Always refuel the machine outdoors.
- Do not store the machine or fuel container indoors where the fumes or fuel can reach an open flame, spark, or pilot light.
- Only store fuel in an approved container. Keep out of the reach of children.
- Never fill containers inside a vehicle or on a truck or trailer bed with a plastic liner. Always place the containers on the ground away from your vehicle before filling.
- Remove the machine from the truck or trailer and refuel it on the ground. If this is not possible, refuel the machine using a portable container, rather than from a fuel dispenser nozzle.
- Never remove the fuel cap or add fuel with the engine running. Allow the engine to cool before refueling.
- Never remove the fuel cap while on a slope. Only remove the fuel cap when parked on a level surface.
- Replace the fuel tank cap and the container cap securely.
- Do not overfill the fuel tank. Only fill to the bottom of the fuel neck, do not fill the fuel neck full. Overfilling of the fuel tank could result in engine flooding, fuel leakage from the tank, and/or damage to the emissions control system.
- If fuel is spilled, do not attempt to start the engine. Move the power unit away from the fuel spill and avoid creating any source of ignition until the fuel vapors have dissipated.

SAFETY



General Safety Procedures for Ventrac Power Units, Attachments, & Accessories



- If the fuel tank must be drained, it should be drained outdoors into an approved container.
- Check the fuel lines for tightness and wear on a regular basis. Tighten or repair them as needed.
- The fuel system is equipped with a shut-off valve. Shut off the fuel when transporting the machine to and from the job, when parking the machine indoors, or when servicing the fuel system.

Hydraulic Safety

- Make sure the hydraulic connections are tight and all hydraulic hoses and tubes are in good condition. Repair any leaks and replace any damaged or deteriorated hoses or tubes before starting the machine.
- Hydraulic leaks can occur under high pressure. Hydraulic leaks require special care and attention.
- Use a piece of cardboard and a magnifying glass to locate suspected hydraulic leaks.
- Keep your body and hands away from pinhole leaks or nozzles that eject high pressure hydraulic fluid. Hydraulic fluid escaping under high pressure can penetrate the skin causing serious injury, leading to severe complications and/or secondary infections if left untreated. If hydraulic fluid is injected into the skin, seek immediate medical attention no matter how minor the injury appears.
- The hydraulic system may contain stored energy. Before performing maintenance or repairs on the hydraulic system, remove any attachments, engage the parking brake, disengage the weight transfer system (if equipped), shut off the engine, and remove the ignition key. To relieve pressure on the auxiliary hydraulic system, shut off the power unit engine and move the hydraulic control lever left and right before disconnecting the auxiliary hydraulic quick couplers.

SAFETY



HQ680 Safety Procedures



Tall grass and thick brush can hide large obstacles such as rocks, tree stumps, etc.

- Inspect the work area for hidden obstacles and remove or mark any obstacles before beginning operation.
- Inspect the area to be mowed and remove all objects that the machine could potentially throw.

Cutting Unit Safety

- Rotating Blade Hazard: Contact with the rotating mower blades or other moving parts may cause personal injury. Keep your hands and feet away.
- Rotation of one blade may cause another blade to rotate.
- Thrown Object Hazard: Do not direct the mower discharge toward people, animals, or buildings. Never operate with the deflector(s) removed.
- Always shut off the PTO to stop the mower blades whenever you are not mowing, especially when crossing loose terrain such as gravel.
- Never raise the mower deck with the blades running.

SAFETY

Safety Decals

The following safety decals must be maintained on your attachment.

Keep all safety decals legible. Remove all grease, dirt, and debris from safety decals and instructional labels. If any decals are faded, illegible, or missing, contact your dealer promptly for replacements.

When new components are installed, be sure that current safety decals are affixed to the replacement components.

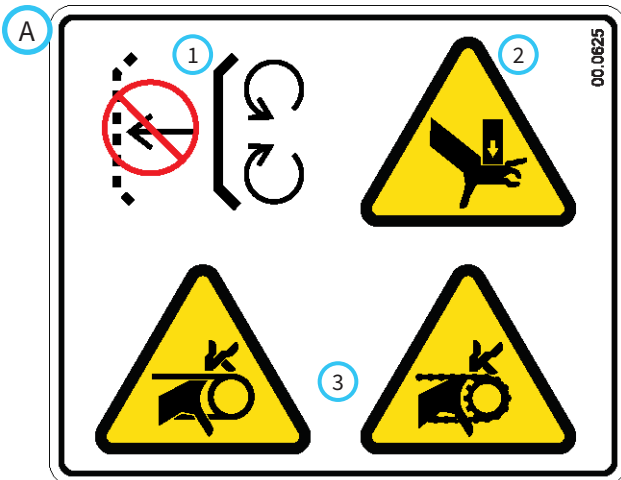
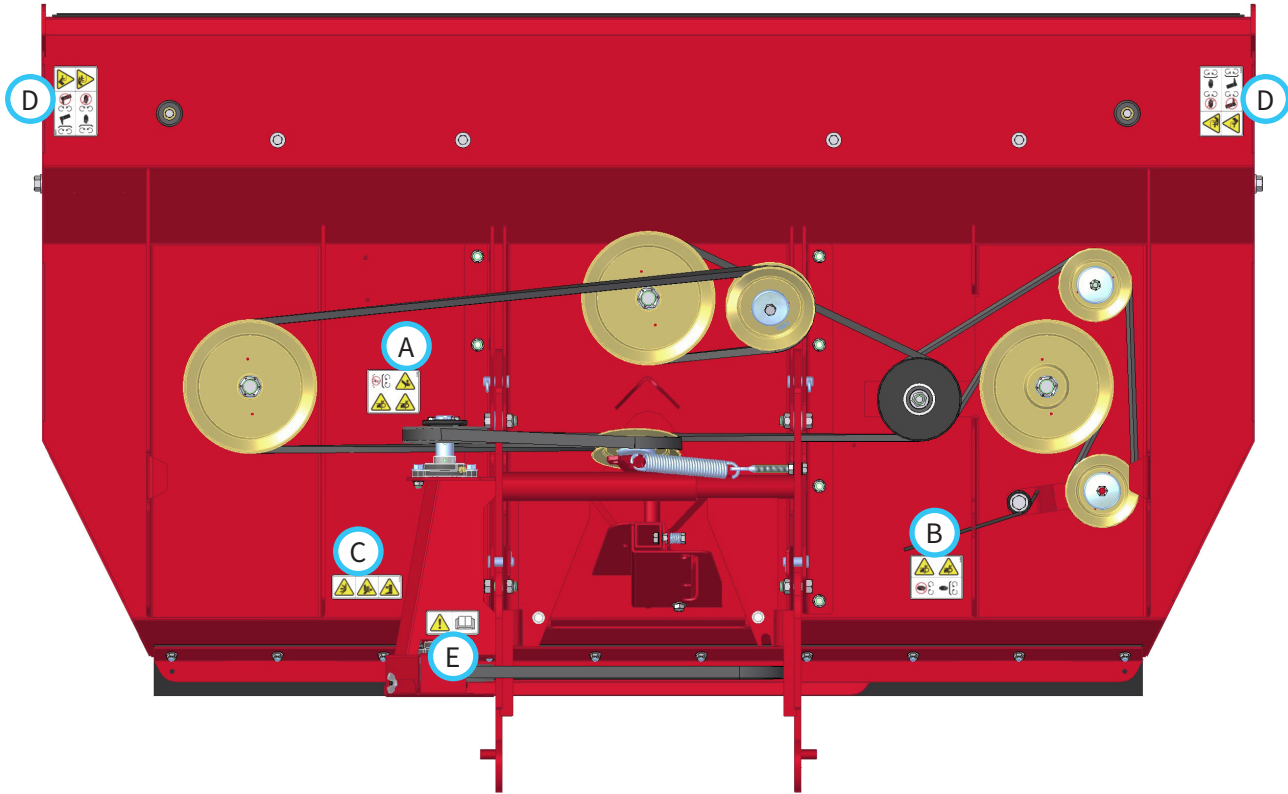

1. Shield missing - do not operate.
2. Pinching/crushing hazard.
3. Fingers or hand entanglement hazard.

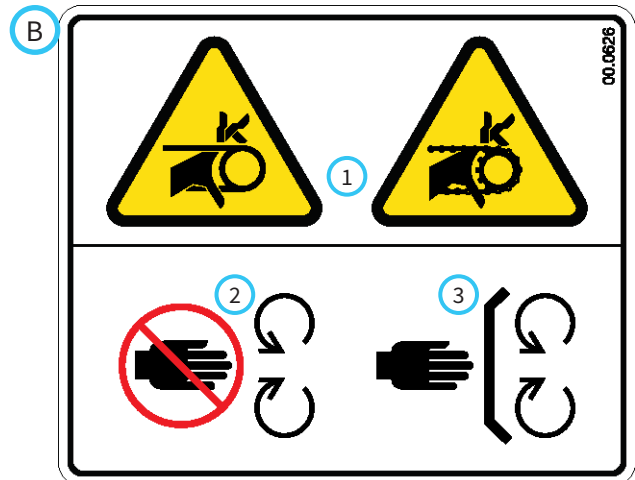

1. Fingers or hand entanglement hazard.
2. Stay away from moving parts.
3. Keep all guards and shields in place.

SAFETY

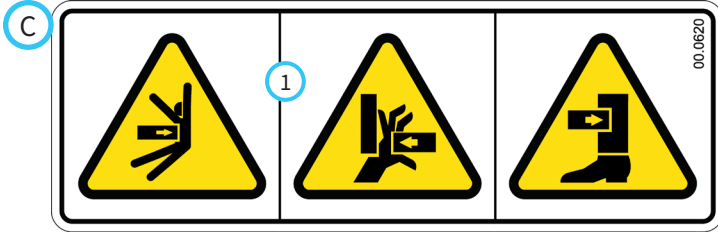

1. Pinching or crushing hazard.

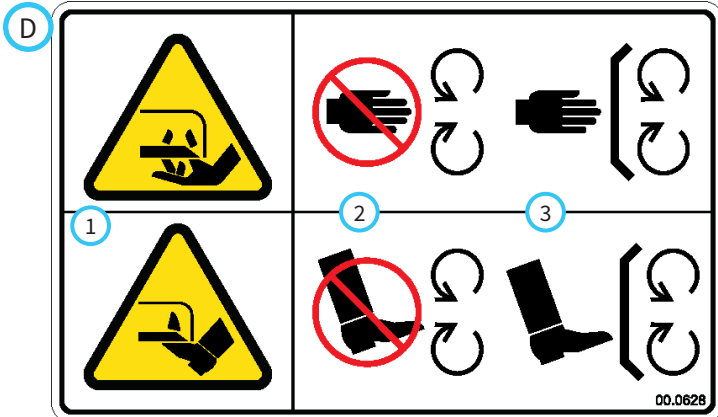

1. Cutting or dismemberment hazard of hand or foot - mower blade.
2. Stay away from moving parts.
3. Keep all guards and shields in place.

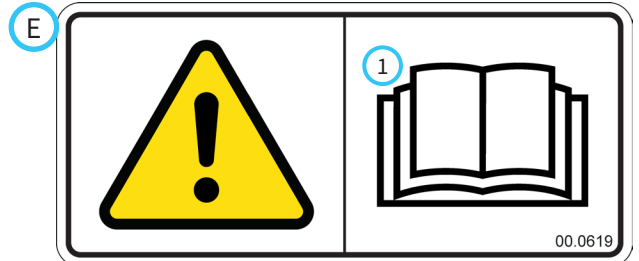

1. Read the operator's manual.

Decal	Description	Part Number	Quantity
A	Shield Missing	00.0625	1
B	Entanglement Hazard	00.0626	1
C	Pinching or Crushing Hazard	00.0620	1
D	Cutting Hazard - Mower Blade	00.0628	2
E	Read Operator's Manual	00.0619	1

OPERATIONAL CONTROLS

Jack Stand

The HQ680 mower is equipped with a jack stand to keep the deck and the hitch arms positioned for quick and easy reattachment to the power unit.

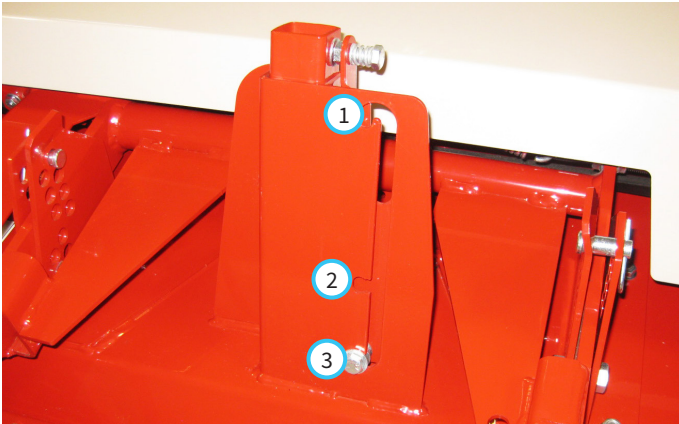

The jack stand has three positions:

1. Place the jack stand in the top position for mowing or transport.
2. Place the jack stand in the middle position when tilting the deck up to the service position. This position allows enough ground clearance to flip the deck up, as well as ensuring the jack stand does not hit the front of the power unit.
3. Place the jack stand in the bottom position for storage, prior to detaching from the power unit.

Primary SDLA Control Lever

Pull the power unit's primary SDLA lever* to the left to raise the mower deck. Push the lever to the right to lower the mower deck to the ground. The control lever must be in the float (detent) position during operation of the mower. Float position is attained by pushing the lever to the right until the float detent locks the lever in place.

Weight Transfer

Terrain and ground conditions may affect the appropriate setting for the power unit's weight transfer system. In most cases, the weight transfer system should be set from 1/2 to 3/4 of maximum capacity.

*Refer to power unit operator's manual for operation of power unit controls.

GENERAL OPERATION

Daily Inspection

WARNING

Always engage the parking brake, shut off the power unit engine, remove the ignition key, and ensure that all moving parts have come to a complete stop before inspecting the components, or attempting any repair or adjustment.

1. Park the machine on a level surface, with the engine shut off and all fluids cold.
2. Perform a visual inspection of both the power unit and the attachment. Look for loose or missing hardware, damaged components, or signs of wear.
3. Inspect the belts for damage or excessive wear. Refer to the Belt Inspection section of this manual.
4. Inspect the mower blades and the mower blade mounting bolts. The blades should be sharp and securely fastened. Service as required.

Attaching

1. Drive the power unit slowly forward into the hitch arms of the attachment. Align the lift arms of the power unit with the attachment hitch arms by raising or lowering the front hitch and complete the engagement.
2. Once completely engaged, close the front hitch locking lever.*
3. Engage the parking brake* and shut off the engine.
4. Place the attachment belt onto the PTO drive pulley on the power unit. Ensure the belt is properly seated in each pulley.
5. Engage the PTO tension spring.

Detaching

1. Park the power unit on a level surface and engage the parking brake.*
2. Lower the attachment to the ground.
3. Shut off the power unit engine.
4. Disengage the PTO tension spring.
5. Remove the attachment belt from the PTO drive pulley of the power unit.
6. Disengage the front hitch locking lever.*
7. Restart the power unit and slowly back away from the attachment. A side to side movement of the steering wheel may aid in disengagement.

Mowing and Operating Procedure

CAUTION

Tall grass and thick brush can hide obstacles such as rocks, tree stumps, etc. Inspect the work area for hidden obstacles and remove or mark any obstacles before beginning operation.

Before operation, perform the daily inspection, confirm that the mower is set to the desired cutting height, and that the hitch pins are properly positioned so the deck is level.

Confirm that the power unit's weight transfer system is set to the proper position.

1. Lower the mower deck to the ground and place the power unit's primary SDLA lever in the float position by pushing it to the right until the detent engages. The lever will stay in this position until intentionally removed.
2. With the power unit's engine running between 2,000 and 3,000 RPM, engage the PTO switch. Adjust the throttle to the desired engine RPM.
3. Drive forward slowly over the mowing area following the desired mowing path. Avoid obstacles and remove debris as needed.
4. Lift the mower deck when the edge of the mowing area is reached.
5. Turn the power unit and mower around and align for the next pass.

*Refer to power unit operator's manual for operation of power unit controls.

GENERAL OPERATION

Transport of Mower

Transport the attachment with the power unit front hitch and attachment fully raised to reduce wear of the equipment. Travel slowly when transporting over undulating and rough surfaces to maintain control of the power unit and to reduce the shock to the power unit and the attachment. Always disengage the power unit PTO before transporting the attachment.

Cutting Height Adjustment (Standard Wheels)

⚠ WARNING

Accidental lowering of the mower deck could trap a person or appendage.

When making adjustments with the mower deck in a raised position, the mower deck must be supported securely with blocks or jack stands.

1. Raise the front of the mower deck and support the mower deck with blocks or jack stands.
2. Remove the wheel mounting bolt (A) and move to the desired position.

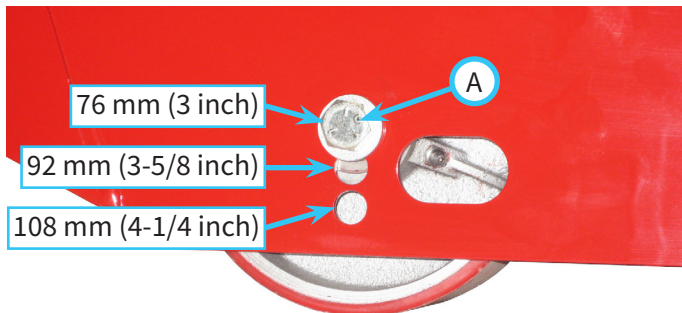

3. Reinstall the wheel mounting bolt and torque to 102 Nm (75 ft-lbs).
4. Repeat for the wheel on the opposite side of the mower deck.
5. Check the mower deck to make sure it is level from front to back. Refer to the Deck Leveling Procedure section of this manual.

Cutting Height Adjustment (Optional Swivel Wheels)

⚠ WARNING

Accidental lowering of the mower deck could trap a person or appendage.

When making adjustments with the mower deck in a raised position, the mower deck must be supported securely with blocks or jack stands.

1. Raise the front of the mower deck and support the mower deck with blocks or jack stands.
2. Use the chart to determine the front wheel and rear pins positions for the desired cutting height.

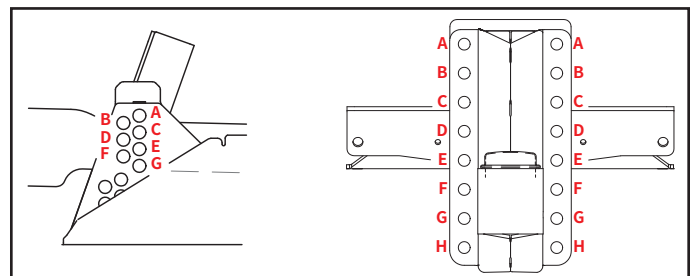

Inches	Millimeters	Rear Pin Position	Front Wheel Position	
			Upper Bolts	Lower Bolts
3-1/2	89	B	E	H
4	102	C	E	H
4-1/2	114	C	D	G
5	127	D	D	G
5-1/2	140	D	C	F
6	152	E	C	F
6-1/2	165	F	B	E
7	178	F	A	D

*Cutting heights are approximate and may vary depending on model of power unit, style of tire, etc.

3. Place the rear pin on both the right and left hitch arms into the desired cutting height position.
4. Remove the four bolts that fasten the swivel wheel frame to the mounting bracket.
5. Move the swivel wheel frame to the desired cutting height position and reinstall the four bolts. Torque to 42 Nm (31 ft-lbs).
6. Repeat for the wheel on the opposite side of the mower deck.

SERVICE

⚠ WARNING

Always engage the parking brake, shut off the power unit engine, remove the ignition key, and ensure that all moving parts have come to a complete stop before inspecting the components, or attempting any repair or adjustment.

ATTENTION

If any component requires replacement, use only original Ventrac replacement parts.

Cleaning and General Maintenance

For best results, and to maintain the finish of the mower, clean or wash the mower to remove accumulated clippings, leaves, and dirt when the job is finished. Refer to the Deck Flip-Up Procedure section to access the underside of the mower deck.

If washing the mower deck, do not spray directly into bearings or seals. After washing, it is important to run the mower so that water does not reside on the seals of the bearings for the drive system. Return the mower deck to the operating position and activate the PTO for 30 seconds to remove any standing water.

Deck Flip-Up Procedure (Service Position)

1. Park the power unit on a smooth, level surface.
2. Engage the parking brake, shut off the engine, and remove the ignition key.
3. Remove the deck cover shield.
4. Remove the two rear pins (A) at the top of the hitch arms and the two lower pins (B) at the front of the hitch arms.

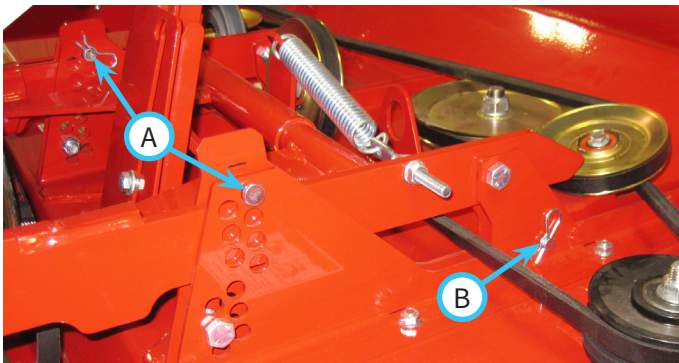

5. Move the jack stand to the middle position.
6. Restart the engine and raise the power unit front hitch to its highest position.
7. Shut off the engine and remove the ignition key.
8. Lift the front of the mower deck up to a near vertical position and reinstall the front pins (C) to lock

the deck in the upright position.

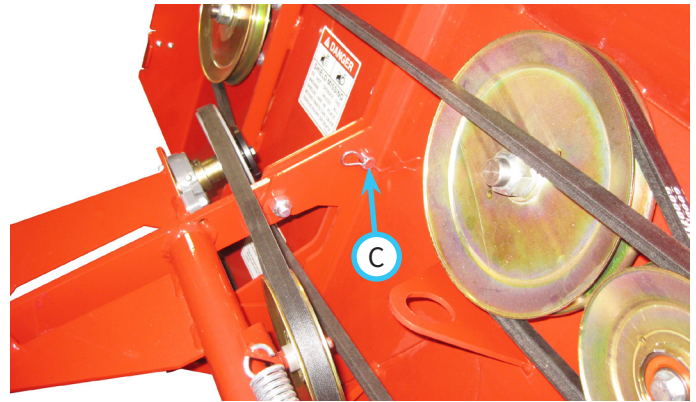

9. To return the deck to the operating position, remove the two pins (C) from the front of the hitch arms and rotate the mower deck to the operating position.
10. Lower the mower deck to the ground.
11. Reinstall the front and rear pins.
12. Reinstall the deck cover shield.

SERVICE

Mower Blade Inspection/Replacement

⚠ CAUTION

Mower blades may be sharp. Always wear heavy gloves when working with mower blades.

1. Rotate the mower deck up to the service position.
2. Inspect the mower blades to ensure the cutting edges are sharp. If the blades are dull or damaged, they must be removed and sharpened or replaced.
3. Place a short piece of 2 x 4 wood between the end of the blade and an appropriate structural part of the mower deck to prevent the blade from rotating.
4. Refer to the following diagram (shown from in front of the mower with the deck flipped up to the service position) to determine the left and right hand spindles and bolt removal direction.

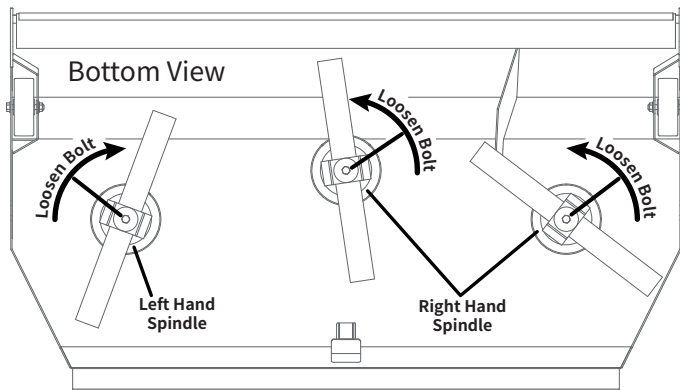

5. Remove the blades for sharpening or replacement.
6. When installing a blade, the wood block must be placed in position to prevent blade rotation when tightening the blade bolt.
7. Torque the blade bolts to 108 Nm (80 ft-lbs).

Mower Blade Sharpening

Blades should be sharpened and balanced by a professional. Maintain the balance, the same bevel, and the length of the sharpened surface.

Belt Inspection

Inspecting the drive belts of the attachment can prevent sudden belt failure by finding problems before they cause a belt to break.

Typical wear on a drive belt may result in the conditions shown in the diagram. If any of these conditions occur, the drive belt will require replacement.

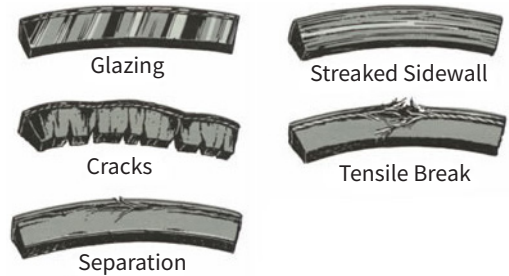

Attachment Drive Belt Replacement

1. Detach the mower deck from the power unit.
2. Remove the drive pulley shield (A).
3. Remove the old attachment drive belt and install the new attachment drive belt onto the pulley.
4. Reinstall the drive pulley shield.

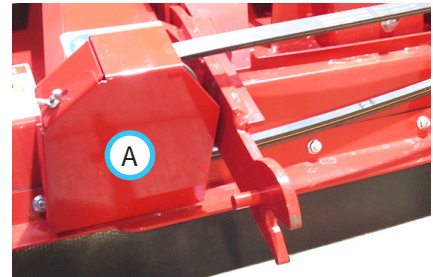

SERVICE

Main Deck Belt Replacement

1. Detach the mower deck from the power unit.
2. Open the main deck cover shield.
3. Release the belt tension by loosening the idler adjustment rod (A).

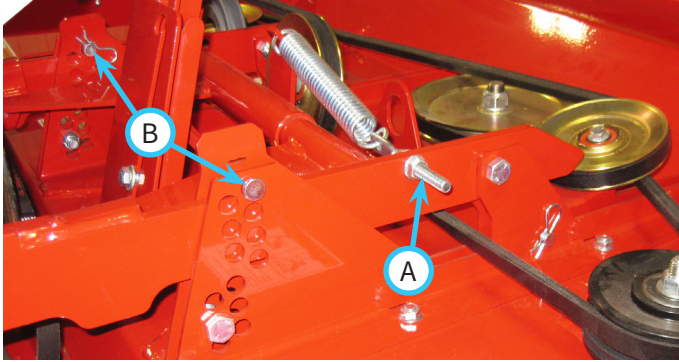

4. Remove the two pins (B) at the top of the hitch arms.

5. Remove the deck belt from the belt tensioner pulley and slide the loop of the belt over the end of the left hitch arm so that the belt is looped around the left hitch arm mounting brackets.

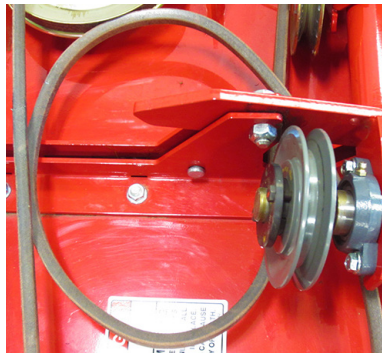

6. Remove the mounting bolts from the left and right hitch arms and lift the hitch arm assembly out of the front mounting brackets.
7. Remove the old belt from the spindle pulleys.
8. Install the new belt onto the spindle pulleys.

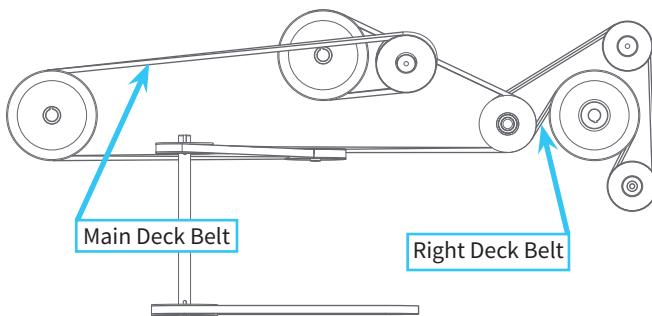

9. Loop the belt around the left hitch arm mounting brackets as shown in the removal step.
10. Reinstall the hitch arm assembly into the mounting brackets and torque the bolts to 102 Nm (75 ft-lbs).
11. Place the belt loop onto the drive shaft pulley and the belt tensioner pulley.
12. Check to ensure the belt is routed properly and seated in the groove of each pulley.

13. Tighten the outer nut on the idler adjustment rod to apply tension to the main deck belt until there is approximately .8 - 1.6 mm (1/32 - 1/16 inch) gap between the spring coils.
14. Tighten the inner nut on the idler adjustment rod against the inner face of the hitch arm to lock the rod in place.
15. Reinstall the two pins at the top of the hitch arms.

SERVICE

Right Deck Belt Replacement

1. Detach the mower deck from the power unit.
2. Open the main deck cover shield.
3. Release the belt tension by loosening the idler adjustment rod (A).
4. Remove the main deck belt from the top groove of the double pulley (B) that drives the right deck belt.
5. Release the right deck belt tensioning spring (C).

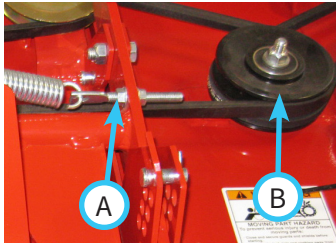

6. Remove the old right deck belt.
7. Install the new right deck belt onto the pulleys as shown in the belt diagram. The right deck belt is installed in the bottom groove of the double pulley.

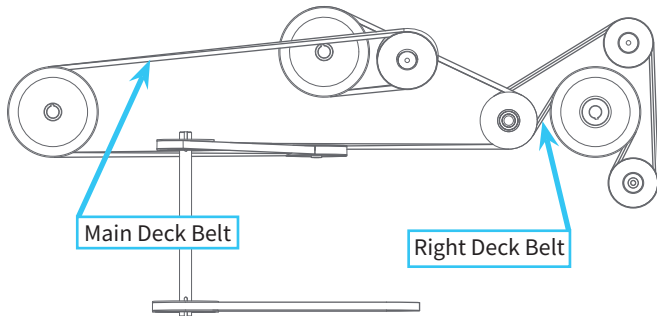

8. Engage the right deck belt tensioning spring.
9. Place the main deck belt into the top groove of the double pulley and ensure the belt is seated in the groove of each pulley.
10. Tighten the outer nut on the idler adjustment rod to apply tension to the main deck belt until there is approximately .8 - 1.6 mm (1/32 - 1/16 inch) gap between the spring coils.
11. Tighten the inner nut on the idler adjustment rod against the inner face of the hitch arm to lock the rod in place.

Main Deck Belt Tension Adjustment

If the belt slips during normal mowing operation, the belt tension will need to be adjusted.

1. Open the main deck cover shield.
2. Loosen the inner nut (A) on the idler adjustment rod (B).

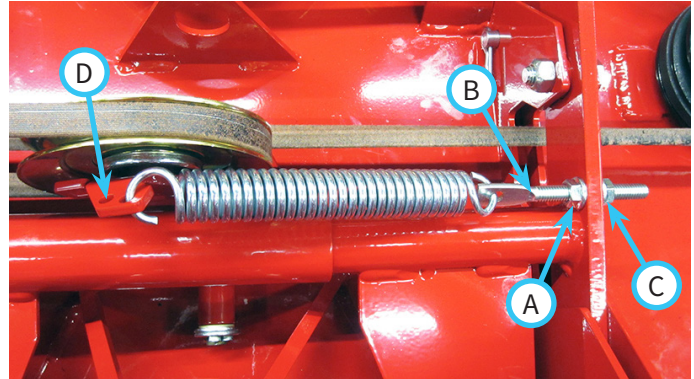

3. Tighten the outer nut (C) on the idler adjustment rod to apply tension to the main deck belt until there is approximately .8 - 1.6 mm (1/32 - 1/16 inch) gap between the spring coils.
4. Tighten the inner nut on the idler adjustment rod against the inner face of the hitch arm to lock the rod in place.
5. If additional belt tension is needed, change the spring hook position to the left hole (D) in the belt pulley idler arm.

SERVICE

Lubrication Locations

Lubrication is required at the following locations using a lithium complex NLGI #2 grease.

Wipe the grease fittings clean before applying grease to the grease fittings.

Refer to the maintenance schedule for service intervals and the amount of grease.

Standard Wheels (Right and Left)

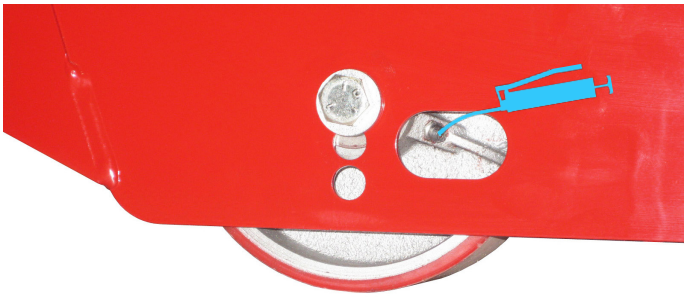

Drive Shaft Bearings

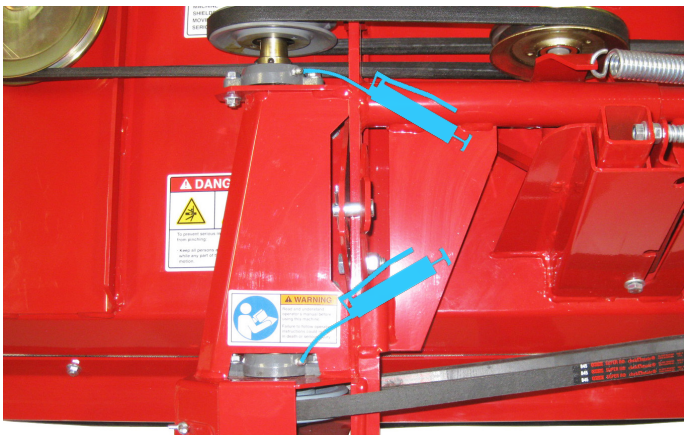

Spindles

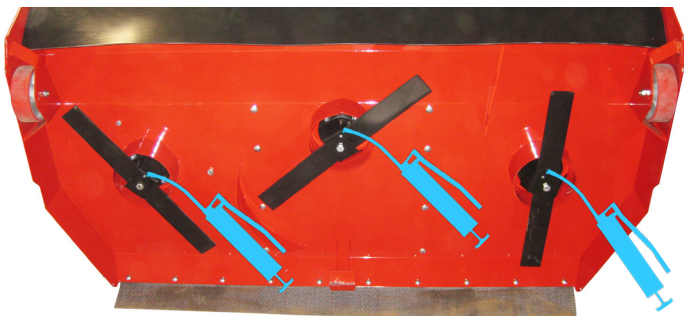

Optional Swivel Wheel Casters and Axles (Right and Left)

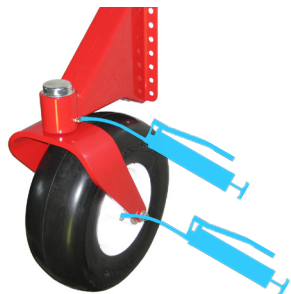

Deck Leveling Procedure

1. Park the power unit on a smooth, level surface.
2. Lower the mower deck to the ground and place the power unit's primary SDLA lever in the float position by pushing it to the right until the detent engages.
3. Engage the parking brake, shut off the engine, and remove the ignition key.
4. Measure the distance from the ground surface to the top surface of the mower deck at the locations shown (A & B). If the measurement at the rear location is less than the front measurement or more than 6.5 mm (1/4 inch) greater than the front measurement, the rear pins (C) will need to be adjusted.

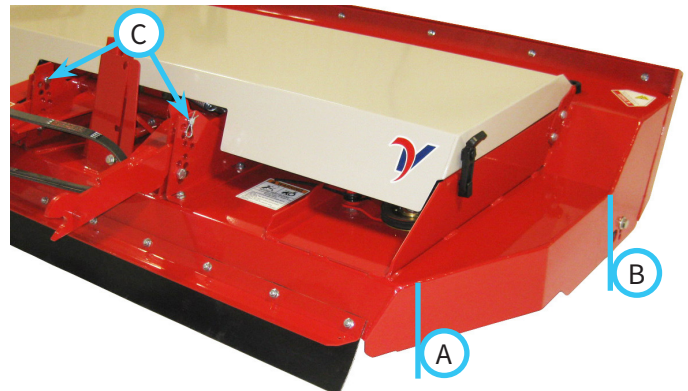

5. To lower the rear of the deck, move the rear pins to a higher position. To raise the rear of the deck, move the rear pins to a lower position.
6. After changing the rear pin position, recheck the deck to confirm it is level.

SERVICE

Storage

Preparing the Attachment for Storage

1. Clean the attachment to remove accumulated clippings, leaves, dust, or other debris.
2. Inspect for loose or missing hardware, damaged components, or signs of wear. Repair or replace any damaged or worn components.
3. Inspect the belts, the spindles, and the mower blades. Repair or replace any damaged or worn components.
4. Inspect the safety decals. Replace any decals that are faded, illegible, or missing.
5. Apply grease to all the grease points and wipe off any excess grease.
6. Inspect the painted components for chips, scratches, or rust. Clean and touch up the surfaces as needed.

Removing the Attachment from Storage

1. Clean the attachment to remove any accumulated dust or debris.
2. Inspect the attachment as instructed in the daily inspection section of this manual.
3. Test the attachment to ensure that all the components are working properly.

SERVICE

Maintenance Schedule

Maintenance Schedule	# of locations	# of pumps	As Needed	Daily	At 50 hours	At 100 hours	At 150 hours	At 200 hours	At 250 hours	At 300 hours	At 350 hours	At 400 hours	At 450 hours	At 500 hours	At 550 hours	At 600 hours	At 650 hours	At 700 hours	At 750 hours	At 800 hours	At 850 hours	At 900 hours	At 950 hours	At 1,000 hours	Yearly
Grease and Lubrication: See Lubrication Section																									
Drive Shaft Bearing	2	1			✓	✓	✓	✓	✓	✓	✓	✓	✓	✓	✓	✓	✓	✓	✓	✓	✓	✓	✓	✓	✓
Caster Wheel	2	1			✓	✓	✓	✓	✓	✓	✓	✓	✓	✓	✓	✓	✓	✓	✓	✓	✓	✓	✓	✓	✓
Spindle	3	3			✓	✓	✓	✓	✓	✓	✓	✓	✓	✓	✓	✓	✓	✓	✓	✓	✓	✓	✓	✓	✓
Optional Wheel - Swivel Bearing	2	1			✓	✓	✓	✓	✓	✓	✓	✓	✓	✓	✓	✓	✓	✓	✓	✓	✓	✓	✓	✓	✓
Optional Wheel - Axle Bearing	2	^	**		✓	✓	✓	✓	✓	✓	✓	✓	✓	✓	✓	✓	✓	✓	✓	✓	✓	✓	✓	✓	✓
Inspection																									
Inspect for Loose, Missing, or Worn Components				✓																					
Inspect the Belts and Pulleys				✓																					
Inspect the Blades and Blade Mounting Bolts				✓																					
Check the Hitch Pivot Bolts (Torque to 102 Nm (75 ft-lbs))					✓		✓		✓		✓		✓		✓		✓		✓		✓		✓		✓
Inspect the Safety Decals				✓																					
^Grease until fresh grease is visible.																									
**Operation in severe conditions may require more frequent service intervals.																									

Maintenance Checklist

Maintenance Schedule	# of locations	# of pumps	As Needed	Daily	At 50 hours	At 100 hours	At 150 hours	At 200 hours	At 250 hours	At 300 hours	At 350 hours	At 400 hours	At 450 hours	At 500 hours	At 550 hours	At 600 hours	At 650 hours	At 700 hours	At 750 hours	At 800 hours	At 850 hours	At 900 hours	At 950 hours	At 1,000 hours	Yearly
Grease and Lubrication: See Lubrication Section																									
Drive Shaft Bearing	2	1																							
Caster Wheel	2	1																							
Spindle	3	3																							
Optional Wheel - Swivel Bearing	2	1																							
Optional Wheel - Axle Bearing	2	^	**																						
Inspection																									
Inspect for Loose, Missing, or Worn Components																									
Inspect the Belts and Pulleys																									
Inspect the Blades and Blade Mounting Bolts																									
Check the Hitch Pivot Bolts (Torque to 102 Nm (75 ft-lbs))																									
Inspect the Safety Decals																									
^Grease until fresh grease is visible.																									
**Operation in severe conditions may require more frequent service intervals.																									

SPECIFICATIONS

Dimensions

Overall Height	46 cm (18 inches)
Overall Length	114 cm (45 inches)
Overall Width	175 cm (69 inches)
Cutting Width	173 cm (68 inches)
Cutting Height Adjustments	7.6, 9.2, and 10.8 cm (3, 3-5/8, and 4-1/4 inches)
Weight	163 kg (360 pounds)

Features

- Heavy duty deck construction
- Rear discharge deck design
- Flip-up deck design
- Field serviceable spindles
- Heavy duty mower blades

Visit ventrac.com/manuals
for the latest version of this operator's manual.
A downloadable parts manual is also available.

View all manuals



WARRANTY



LIMITED WARRANTY - VENTRAC COMMERCIAL EQUIPMENT

Venture Products, Inc., (henceforth referred to as V.P.I.) warrants on the terms and conditions herein, that it will repair, replace, or adjust any part manufactured by Venture Products Inc., and found by Venture Products, Inc., to be defective in material and/or workmanship during the applicable warranty term.

All Ventrac commercial equipment purchased and registered on or after January 1, 2019 will carry a 2-year commercial warranty. The warranty period begins on the date of the original customer purchase:

Ventrac Commercial Equipment	Warranty Term
2100 SSV & Attachments	2-year
3000 Series Tractors & Attachments	2-year
4000 Series Tractors & Attachments	2-year

All Ventrac add-on kits and accessories such as: 3-point hitch, 12V front & rear power outlets, foot pedal, dual wheel kit, etc., will be covered under the above warranty periods provided they are installed by an Authorized Ventrac Dealer. This warranty may be transferred and will carry the remainder of the warranty starting from the original purchase/registration date with the dealership and/or V.P.I.

The engine warranty is covered by its respective engine manufacturer. Please refer to the engine manufacturer's warranty statement that is included in the owner's manual.

For warranty consideration on Ventrac commercial equipment, the equipment, including any defective part, must be returned to an Authorized Ventrac Dealer within the warranty period. The warranty shall extend to the cost to repair or replace (as determined by V.P.I.) the defective part. The expense of pickup and delivery of the equipment, the service call drive time or any transportation expense incurred for the warranty repair is the sole responsibility of the owner and is not covered under warranty by Ventrac and/or V.P.I. Ventrac and V.P.I.'s responsibility in respect to claims is limited to making the required repairs or replacements, and no claim of breach of warranty shall be cause for cancellation or rescission of the contract of sale of any Ventrac equipment. Proof of purchase may be required by the dealer to substantiate any warranty claim. Only warranty work performed and submitted by an Authorized Ventrac Dealer may be eligible for warranty credit.

This warranty extends only to Ventrac commercial equipment operated under normal conditions and properly serviced and maintained. The warranty expressly does NOT cover: (a) any defects, damage or deterioration due to normal use, wear and tear, or exposure; (b) normal maintenance services, such as cleaning, lubrication, oil change; (c) replacement of service items, such as oil, lubricants, spark plugs, belts, rubber hoses, bearings or other items subject to normal service replacement; (d) damage or defects arising out of, or relating to abuse, misuse, neglect, alteration, negligence or accident; (e) repair or replacement arising from operation of, or use of the equipment which is not in accordance with the operating instructions as specified in the operator's manual or other operational instructions provided by V.P.I.; (f) repair or replacement arising as a result of any operation from Ventrac equipment that has been altered or modified so as to, in the determination of V.P.I., adversely affect the operation, performance or durability of the equipment or that has altered, modified or affected the equipment so as to change the intended use of the product; (g) repair or replacement necessitated by the use of parts, accessories or supplies, including gasoline, oil or lubricants, incompatible with the equipment or other than as recommended in the operator's manual or other operational instructions provided by V.P.I.; (h) repairs or replacements

WARRANTY



LIMITED WARRANTY - VENTRAC COMMERCIAL EQUIPMENT

resulting from parts or accessories which have adversely affected the operation, performance or durability of the equipment; or (i) damage or defects due to or arising out of repair of the Ventrac equipment by a person or persons other than an authorized Ventrac service dealer or the installation of parts other than genuine Ventrac parts or Ventrac recommended parts.

The sole liability of V.P.I. with respect to this warranty shall be the repair and replacement as set forth herein. V.P.I. shall have no liability for any other cost, loss, or damage. In particular V.P.I. shall have no liability or responsibility for: (i) expenses relating to gasoline, oil, or lubricants; (ii) loss, cost or expense relating to transportation or delivery of turf equipment from the location of the owner or the location where used by the owner to or from any Authorized Ventrac Dealer; (iii) travel time, overtime, after hours' time or other extraordinary repair charges or charge relating to repairs or replacements outside of normal business hours at the place of business of an Authorized Ventrac Dealer; (iv) rental of like or similar replacement equipment during the period of any warranty repair or replacement work; (v) any telephone or telegram charges; (vi) loss or damage to person or property other than that covered by the terms of this warranty; (vii) any claims for lost revenue, lost profit or additional cost or expense incurred as a result of a claim of breach of warranty; or (viii) attorney's fees.

The remedies of the buyer set forth herein are exclusive and are in lieu of all other remedies. The liability of V.P.I., whether in contract, tort, under any warranty, or otherwise, shall not extend beyond its obligation as set forth herein. V.P.I. shall not be liable for cost of removal or installation nor shall V.P.I. be responsible for any direct, indirect, special or consequential damages of any nature. In no event shall V.P.I. be liable for any sum in excess of the price received for the goods for which a liability is claimed.

There are no representations or warranties which have been authorized to the buyer of the Ventrac commercial equipment other than set forth in this warranty. Any and all statements or representations made by any seller of this equipment, including those set forth in any sales literature or made orally by any sales representative, are superseded by the terms of this warranty. Any affirmation of fact or promise made by V.P.I. or any of its representatives to the buyer which relates to the goods that are the subject to this warranty shall not be regarded as part of the basis of the bargain and shall not be deemed to create any express warranty that such goods shall conform to the affirmation or promise.

No employee, distributor, or representative is authorized to change the foregoing warranties in any way or grant any other warranty on behalf of V.P.I.

Some states do not allow limitations on how long an implied warranty lasts or allow the exclusion on limitation of incidental or consequential damages, so the above limitation or exclusion may not apply to you.

This warranty gives you specific legal rights, and you may also have other rights which vary from state to state.

This warranty applies to all Ventrac commercial equipment sold by Venture Products Inc.